

Wiringkit



- D** Einbauanleitung
- GB** Installation instructions
- F** Consignes de montage
- NL** Montagehandleiding
- DK** Montagevejledning
- N** Monteringsinstruksjon
- S** Installationsanvising
- FIN** Asennusohje
- I** Istruzioni per il montaggio
- E** Instrucciones de montaje
- P** Instruções de montagem
- GR** Οδηγίες εγκατάστασης
- CZ** Návod k montáži
- SLO** Navodilo za vgradnjo
- SK** Montážny návod
- PL** Instrukcja montażu
- TR** Montaj talimatı
- H** Beépítési útmutató
- HR** Upute o ugradnji
- BUL** инструкции за монтаж
- RO** Instrucțiuni de montaj
- RU** Инструкция по монтажу и установке
- LT** Montavimo informacija
- LV** Iemontešanas pamacība
- EST** Paigaldusjuhend

701523 AUDI

- **Q2** 10/16 →
- **Q3 (F3)** 12/18 →
- **Q3 (F3) Sportback** 10/19 →

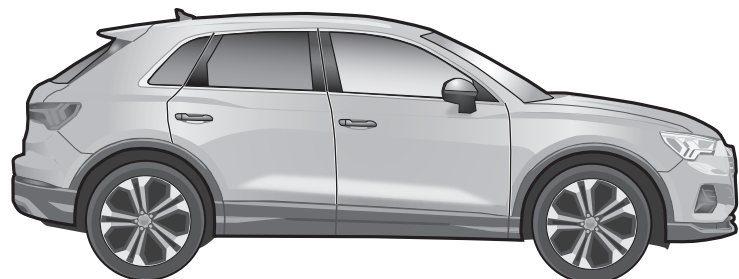
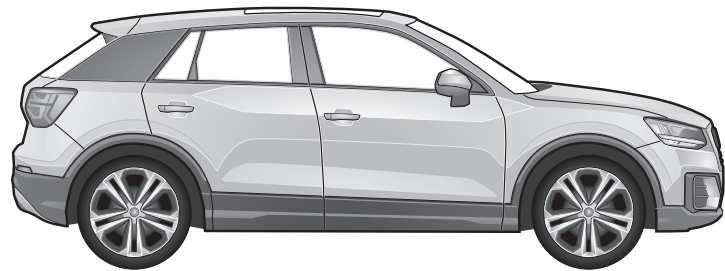

BRiNK[®]

Your perfect fit
brink.eu

WICHTIG!

D Der Einbau dieses Elektrosatzes muß von einer Fachwerkstatt oder einer entsprechend qualifizierten Person durchgeführt werden. Vor Beginn aller Montagearbeiten unbedingt die Einbauanleitung komplett durchlesen. Nach Einbau des Elektrosatzes ist die Einbauanleitung den Serviceunterlagen des Fahrzeuges beizulegen!

Bei unsachgemäßer Anwendung oder Veränderung des Elektrosatzes bzw. der darin befindlichen Bauteile erlischt jeder Anspruch auf Gewährleistung. Beim Fahren ohne Anhänger oder Ladungsträger müssen ggf. verwendete Adapter immer aus der Steckdose entfernt werden. Änderungen bezüglich Konstruktion, Ausstattung, Farbe sowie Irrtum vorbehalten. Alle Angaben und Abbildungen unverbindlich.

Bei Anhängern ohne Nebelschlussleuchte sollte diese nachgerüstet werden.

Für technische bzw. elektronische Änderungen, welche nach erstmaliger Inbetriebnahme des Elektrosatzes vom Fahrzeughersteller durchgeführt werden und beispielsweise zu Fehlfunktionen der Anhängersteckdose oder deren Peripherie führen, übernehmen wir keinerlei Gewährleistung!

Das Anhängermodul ist nicht diagnosefähig! Sollten herstellereitige Diagnoseprozesse bzw. softwaregestützte Prüfmechanismen Fehlerprotokolle generieren, welche direkt oder indirekt mit Anhängerbetrieb in Zusammenhang stehen, ist das Anhängermodul vom Leitungssatz für die Anhängersteckdose zu trennen und ein nochmaliger Diagnosevorgang zu starten!

IMPORTANT!

GB Installation of the towing electrics kit must be undertaken by a specialist workshop or an appropriately qualified person. Before starting work, you must read the installation instructions through completely. After installing the towing electrics kit, the installation instructions should be kept with the vehicle service documentation.

All claims under the guarantee will lapse in case of improper use or modification of the towing electrics kit or any of its component parts. When driving without a trailer or load carrier, any adapter installed must be removed from the electrical socket. We reserve the right to alter the design, content or colour. We accept no liability for any errors in these instructions. All details and illustrations are non-binding.

In case of missing a rear fog lamp on the trailer, it should be retrofitted.

We accept no responsibility and give no guarantee for technical and electrical modifications made after the initial operation of the towing electrics kit by the vehicle manufacturer and which may lead, for example to malfunction of the trailer socket or its peripheries.

The trailer module is not diagnostics-capable. If the manufacturer's diagnostics processes or software-supported test mechanisms generate error reports directly or indirectly linked with trailer operation, the trailer module must be disconnected from the leads to the trailer socket and a new diagnostic process initiated.

IMPORTANT!

F Le montage du faisceau doit être effectué par un atelier spécialisé ou par une personne qualifiée en la matière. Avant le début des travaux, lire impérativement les instructions de montage dans leur intégralité. Après le montage du faisceau, joindre les instructions de montage aux documents du véhicule.

Un usage inapproprié ou des modifications du faisceau, ou des pièces qui le composent, entraînent l'expiration de tout droit à la garantie. Lors d'une conduite sans remorque ou porteur de charge, les adaptateurs utilisés doivent, le cas échéant, toujours être enlevés de la prise de courant. Sous réserve de modifications de constructions, équipement, couleurs ou erreur. Données et illustrations sous toute réserve.

Si la remorque n'est pas équipée de feux anti-brouillard arrière, il devra être posé ultérieurement.

Nous n'assumons aucune responsabilité ni garantie pour les modifications techniques et électroniques ayant été effectuées après la première mise en service du kit de connexion électrique par le constructeur automobile et ayant mené par exemple à des mauvais fonctionnements de la prise de remorque ou de sa périphérie.

Le module remorque ne contient pas de fonction diagnostic! Au cas où des processus de diagnostic définis par le fabricant ou des mécanismes de contrôle assistés par ordinateur devaient générer des messages d'erreur directement ou indirectement en rapport avec le fonctionnement de la remorque, il est impératif pour la prise de remorque de détacher le module remorque du groupe électrique et d'initier une nouvelle procédure de diagnostic.

IMPORTANT!

I L'installazione del kit elettrico deve essere effettuata da un officina o da personale specializzato. Prima di iniziare tutti i lavori di montaggio, leggere da cima a fondo le istruzioni. Dopo aver installato il kit elettrico si prega di allegare le istruzioni di montaggio ai documenti di manutenzione del veicolo!

In caso di uso improprio o di modifiche del kit elettrico e delle componenti del medesimo, ogni diritto di garanzia decade. Durante la guida senza rimorchio o portacarichi, togliere sempre gli adattatori dalla presa di corrente. Con riserva di modifiche relative a costruzione, equipaggiamento, colore e salvo errori. Tutte le indicazioni e illustrazioni non sono vincolanti.

In caso di rimorchi non corredati di luce retronebbia, questa dovrebbe essere installata.

Per le modiche tecniche ed elettroniche eseguite dopo la prima messa in funzione del kit elettrico da parte del costruttore del veicolo, e che portano, per esempio, a un malfunzionamento della presa del rimorchio o della sua periferia, non ci assumiamo alcuna responsabilità!

Il modulo del rimorchio non è idoneo alla diagnosi! Nel caso in cui processi diagnostici o apparecchiature di prova controllate da software dovessero generare dei protocolli d'errore in rapporto diretto o indiretto con l'uso del rimorchio, si deve staccare il modulo del rimorchio dal conduttore per la presa del rimorchio, e avviare nuovamente la diagnosi!

¡IMPORTANT!

E El montaje del equipo eléctrico deberá llevarse a cabo en un taller especializado o por parte de una persona correspondientemente calificada. Antes de comenzar cualquier trabajo de montaje es imprescindible haberse leído las instrucciones de montaje por completo. ¡Después de haber realizado el montaje del equipo eléctrico deben adjuntarse las instrucciones de montaje a los documentos de servicio del vehículo!

En caso de una utilización inadecuada o de una modificación del equipo eléctrico o de los componentes incluidos respectivamente se extinguirá cualquier derecho de garantía. En caso de conducir sin remolque o sin portacargas deberán sacarse siempre del enchufe los adaptadores que hayan podido ser utilizados. Queda reservado el derecho de modificaciones con respecto a la construcción, el equipamiento, el color y de errores. Todas las informaciones y reproducciones se entienden sin compromiso.

Al tratarse de remolques sin luz antiniebla trasera, esta debería ser reequipada.

¡No asumiremos ninguna clase de garantía por modificaciones técnicas o electrónicas respectivamente que se lleven a cabo después de la primera puesta en funcionamiento del equipo eléctrico por parte del fabricante del vehículo y que puedan provocar por ejemplo un mal funcionamiento del enchufe del remolque o de los correspondientes componentes periféricos!

¡El módulo para el remolque no puede someterse a un diagnóstico! En caso de que los procesos de diagnóstico por parte del fabricante o que los mecanismos de comprobación asistidos por software generen informes de errores que estén directa o indirectamente relacionados con el servicio con remolque, deberá separarse el módulo para el remolque de los cables de conexión para el enchufe del remolque e iniciarse un nuevo proceso de diagnóstico!

BELANGRIJK!

NL De inbouw van deze elektrosat moet door een vakwerkplaats of door een overeenkomstig gekwalificeerde persoon gebeuren. Vóór aanvang van alle montagewerkzaamheden absoluut de montagehandleiding volledig doorlezen. Na inbouw van de elektrosat dient de montagehandleiding bij de servicedocumenten van het voertuig te worden gelegd!

Bij ondeskundige toepassing of wijziging van de elektrosat c.q. van de daarin zittende componenten vervalt elke aanspraak op fabrieksgarantie. Tijdens het rijden zonder aanhanger of ladingdrager moeten evtl. gebruikte adapters altijd uit de stekkerdoos worden verwijderd. Wijzigingen met betrekking tot constructie, uitvoering, kleur alsmede vergissing voorbehouden. Alle opgaven en afbeeldingen niet-bindend.

Bij aanhangers zonder mistachterlicht dient dit achteraf te worden gemonteerd.

Wij verlenen generlei fabrieksgarantie voor technische c.q. elektronische wijzigingen die na de eerste inbedrijfstelling van de elektrosat door de voertuigfabrikant worden uitgevoerd en bijvoorbeeld leiden tot foutieve functies van de stekkerdoos van de aanhanger of diens periferie!

De aanhangermodule kan niet worden gediagnosticeerd! Mochten diagnoseprocessen van de kant van de fabrikant c.q. op software steunende testmechanismen foutprotocollen genereren die direct of indirect in verband staan met het gebruik van de aanhanger, dan dient de aanhangermodule te worden losgekoppeld van de kabelset voor de aanhangerstekkerdoos en dient het diagnoseproces nogmaals te worden gestart!

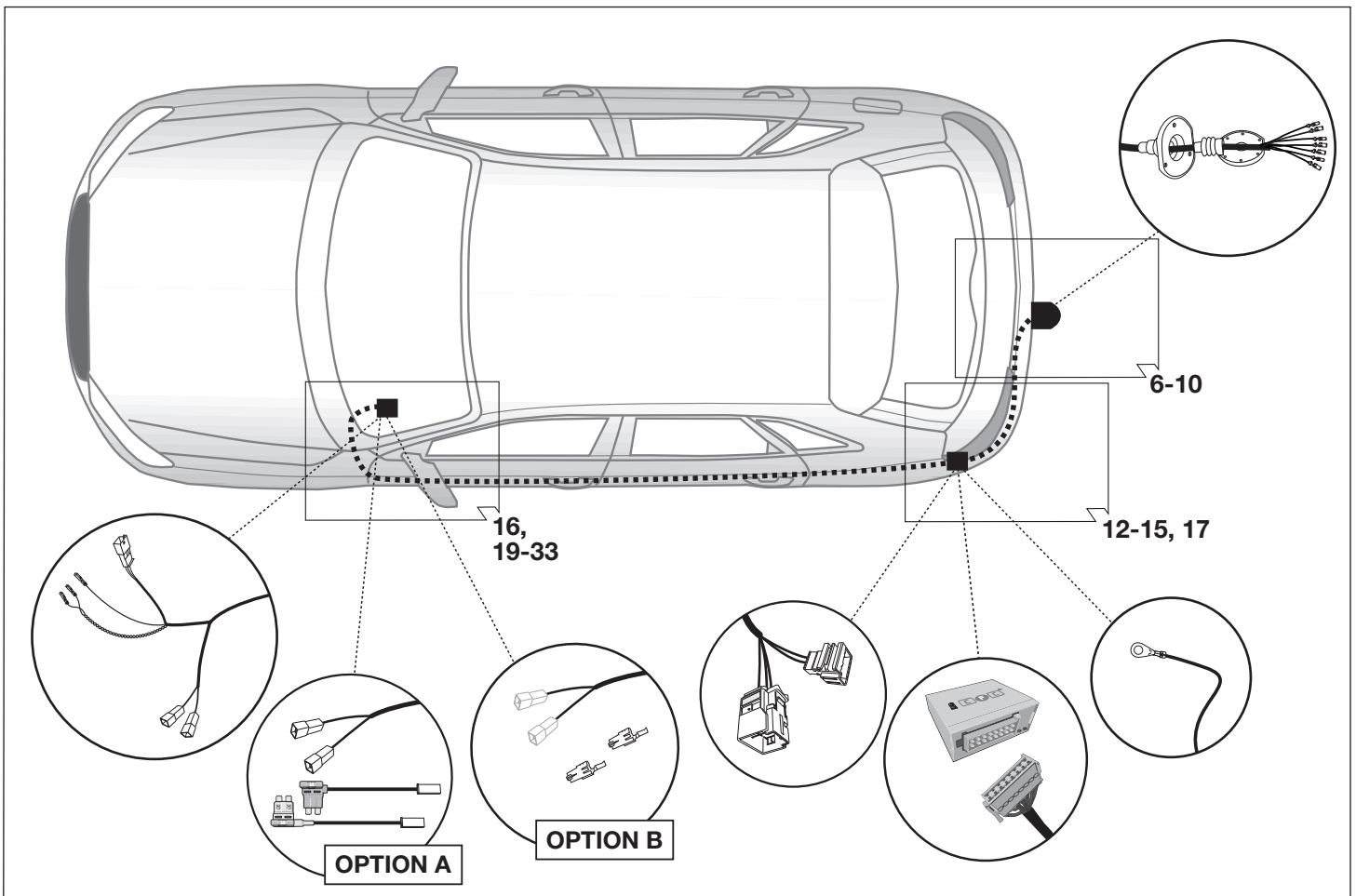
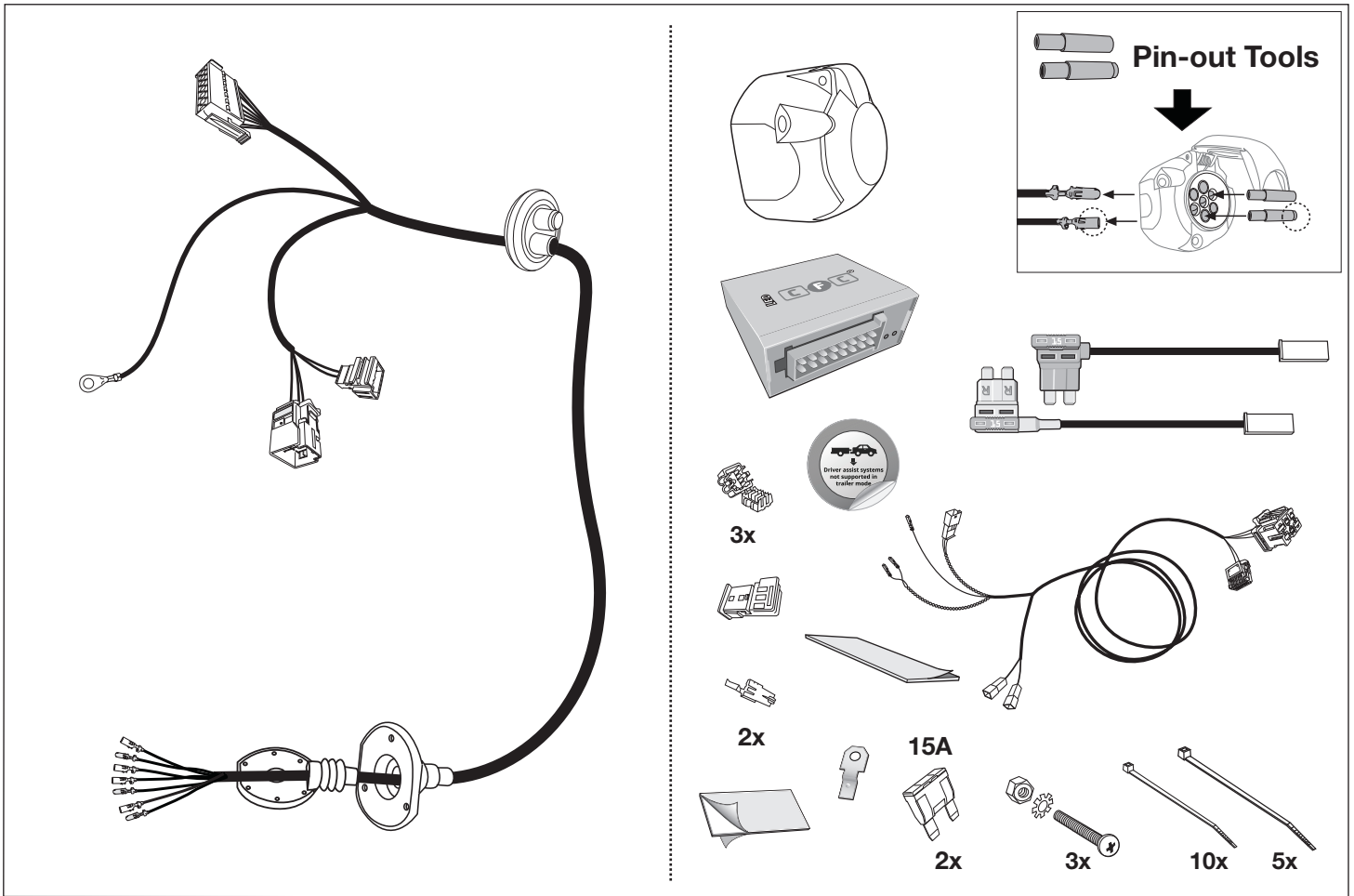

Werkzeuge - Tools - Outils - Utensile - Herramientas - Werktuigen

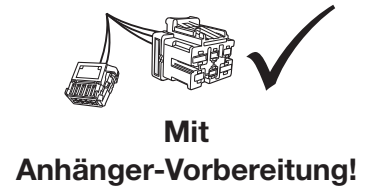
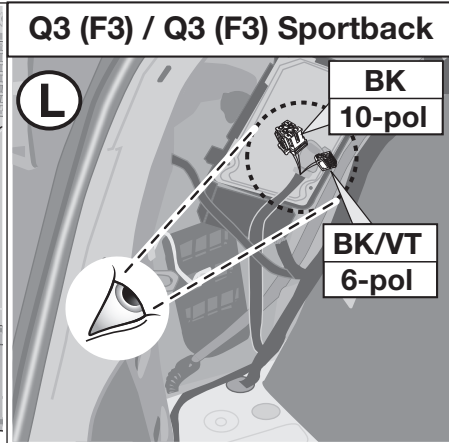
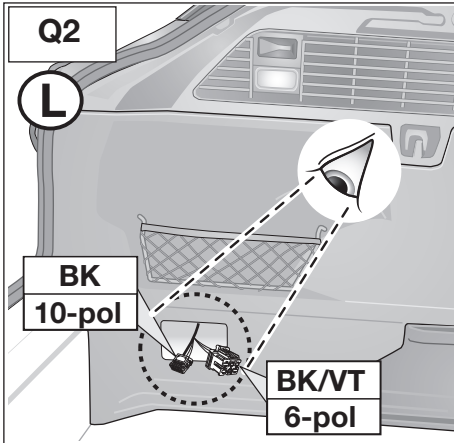
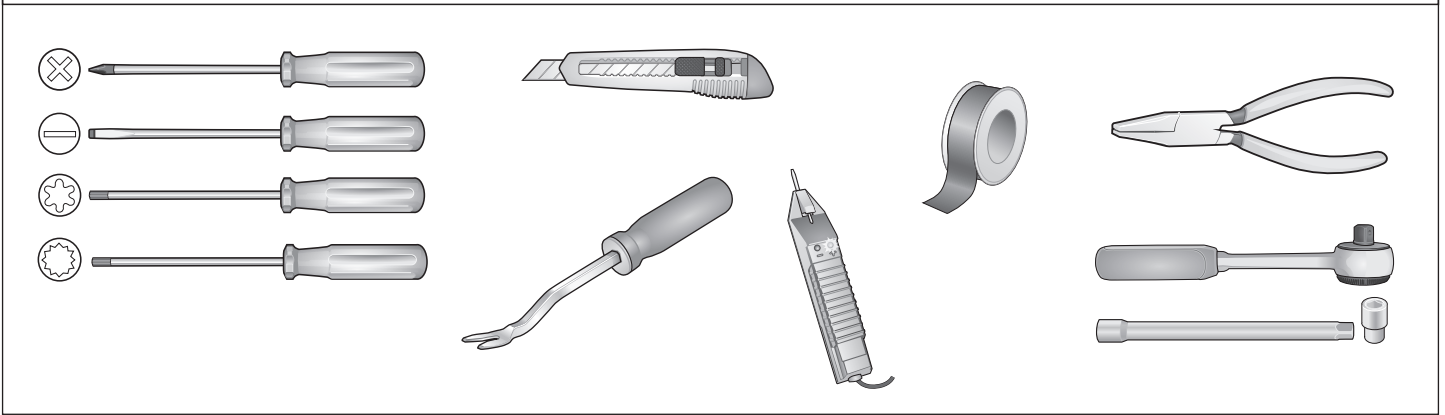

ACHTUNG!	ATTENTION!	ATTENTION!	ATTENZIONE!	¡ATENCIÓN!	ATTENTIE!
(D)	(GB)	(F)	(I)	(E)	(NL)
Die Kühlerleistung des Fahrzeuges muß bei Nachrüstung einer Anhängerkupplung möglicherweise erhöht werden! Bitte unbedingt Herstellerangaben beachten!!	The vehicle's cooling capacity may have to be increased when retrofitting a trailer coupling! You must observe the manufacturer's instructions!!	Il peut s'avérer nécessaire d'augmenter la puissance du radiateur du véhicule lorsque celui est équipé ultérieurement d'un attelage remorque! Respecter impérativement les instructions du constructeur!!	La capacità di raffreddamento del veicolo, quando si applica un gancio di traino, si deve possibilmente aumentare! Si prega di osservare tassativamente le indicazioni del produttore!!	¡Es posible que haya que aumentar la capacidad del radiador en caso de reequipar un acoplamiento de remolque! ¡Rogamos tener en cuenta las instrucciones de fabricante sin falta!	Het koelvermogen van het voertuig moet mogelijk worden verhoogd als achteraf een aanhangerkoppeling wordt aangebracht! Absoluut de fabrieksopgaven in acht nemen a.u.b.!!

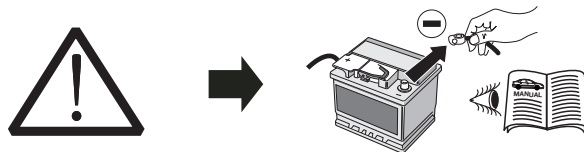

ACHTUNG!	ATTENTION!	ATTENTION!	ATTENZIONE!	¡ATENCIÓN!	ATTENTIE!
Um Störungen und Schäden am Bordnetz zu vermeiden, muss die Massepolklemme unbedingt vor Beginn aller Arbeiten von der Fahrzeugbatterie getrennt werden! Insbesondere bei Arbeiten und Anschlüssen am CAN-Datenbus kann bei nicht abgeklemmter Batterie sowohl das Anhängermodul als auch das fahrerseitige Bordnetzsteuergerät beschädigt werden! Bitte Herstellervorschriften beim Ab- und Anklemmen der Fahrzeugbatterie beachten!	In order to avoid malfunctions and damage to the vehicle's electrical system the earth terminal must be disconnected from the vehicle's battery before starting work! Both the trailer module and the vehicle's control unit for the electrical system can be damaged during work on the CAN data bus connections if the battery is not disconnected! Please pay attention to the manufacturer's instructions when disconnecting and reconnecting the vehicle's battery!	Afin d'éviter tout dysfonctionnement ou endommagement du circuit de bord, il est indispensable de débrancher la pince de masse de la batterie du véhicule avant le début de toute opération! En particulier s'il s'agit de travaux et de branchements effectués sur le bus de données CAN, si la batterie n'est pas débranchée, le module remorque aussi bien que le dispositif de commande de circuit de bord du véhicule risquent d'être endommagés! Veuillez respecter les directives du fabricant lors du branchement et du débranchement de la batterie du véhicule!	Per evitare disturbi e danni alla rete di distribuzione elettrica, l'espansione polare a massa deve essere assolutamente scollegata dalla batteria del veicolo prima dell'inizio dei lavori! In particolare durante i lavori e gli allacciamenti al bus di dati CAN, se la batteria non è scollegata si possono danneggiare sia la centralina rimorchio, sia la centralina della rete di distribuzione elettrica del veicolo! Attenersi alle indicazioni del costruttore per scollegare e ricollegare la batteria del veicolo!	¡Para evitar fallos y defectos en el sistema eléctrico de a bordo es imprescindible separar al terminal de puesta a tierra de la batería del vehículo antes de realizar cualquier trabajo! ¡Particularmente al realizar trabajos y conexiones al bus de datos CAN puede estropearse tanto el módulo para remolques como el regulador del sistema eléctrico de a bordo del vehículo si no se ha desconectado la batería! ¡Rogamos observar las instrucciones del fabricante al conectar y desconectar la batería del vehículo!	Om storingen en schade aan elektrische bedrading te vermijden moet de massapoolklem absoluut vóór aanvang van alle werkzaamheden worden losgekoppeld van de voertuigaccu! Vooral bij werkzaamheden aan en aansluitingen op de CAN-databus kan zowel de aanhangermodule als de voertuigzijdige regeleenheid voor de elektrische installatie beschadigd worden, als de accu niet ontkoppeld is! Fabrieksvoorschriften bij het vast- en loskoppelen van de voertuigaccu in acht nemen a.u.b.!

Q2

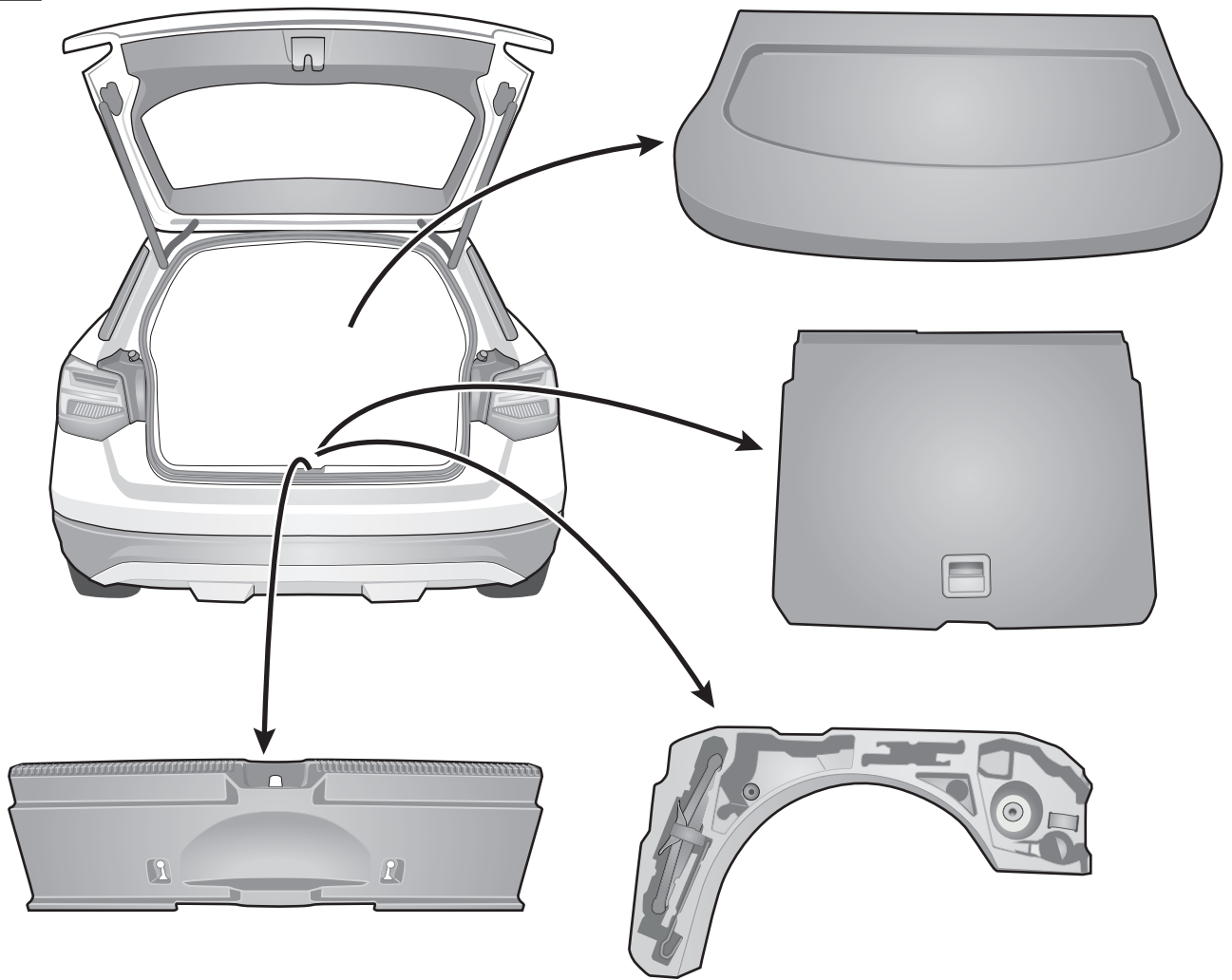

L

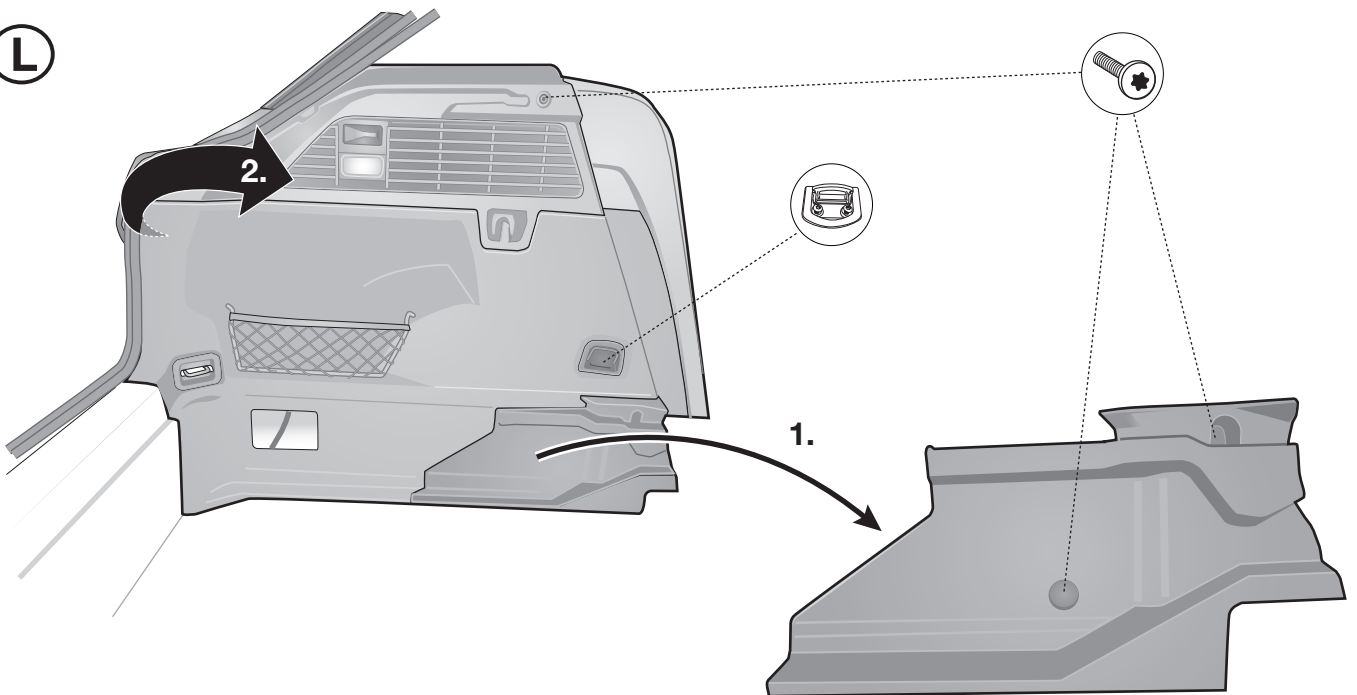

2

Q3 (F3) / Q3 (F3) Sportback

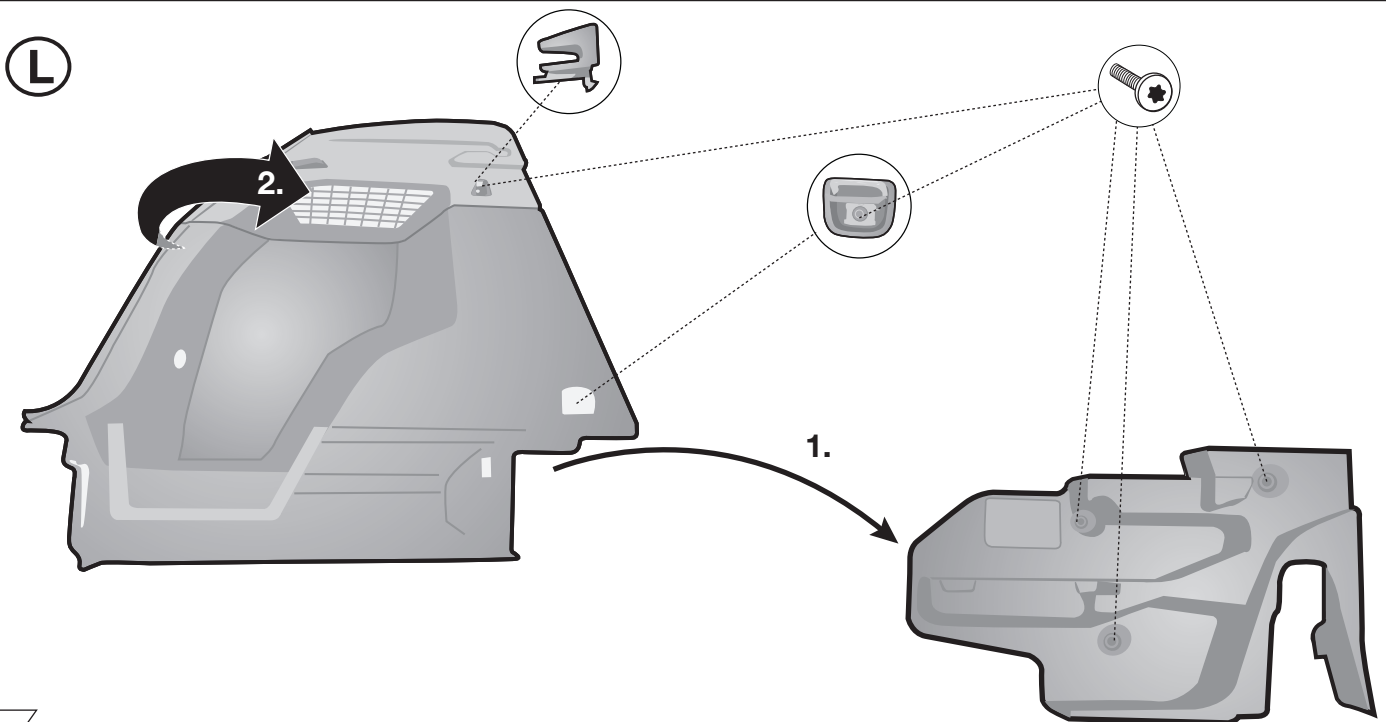
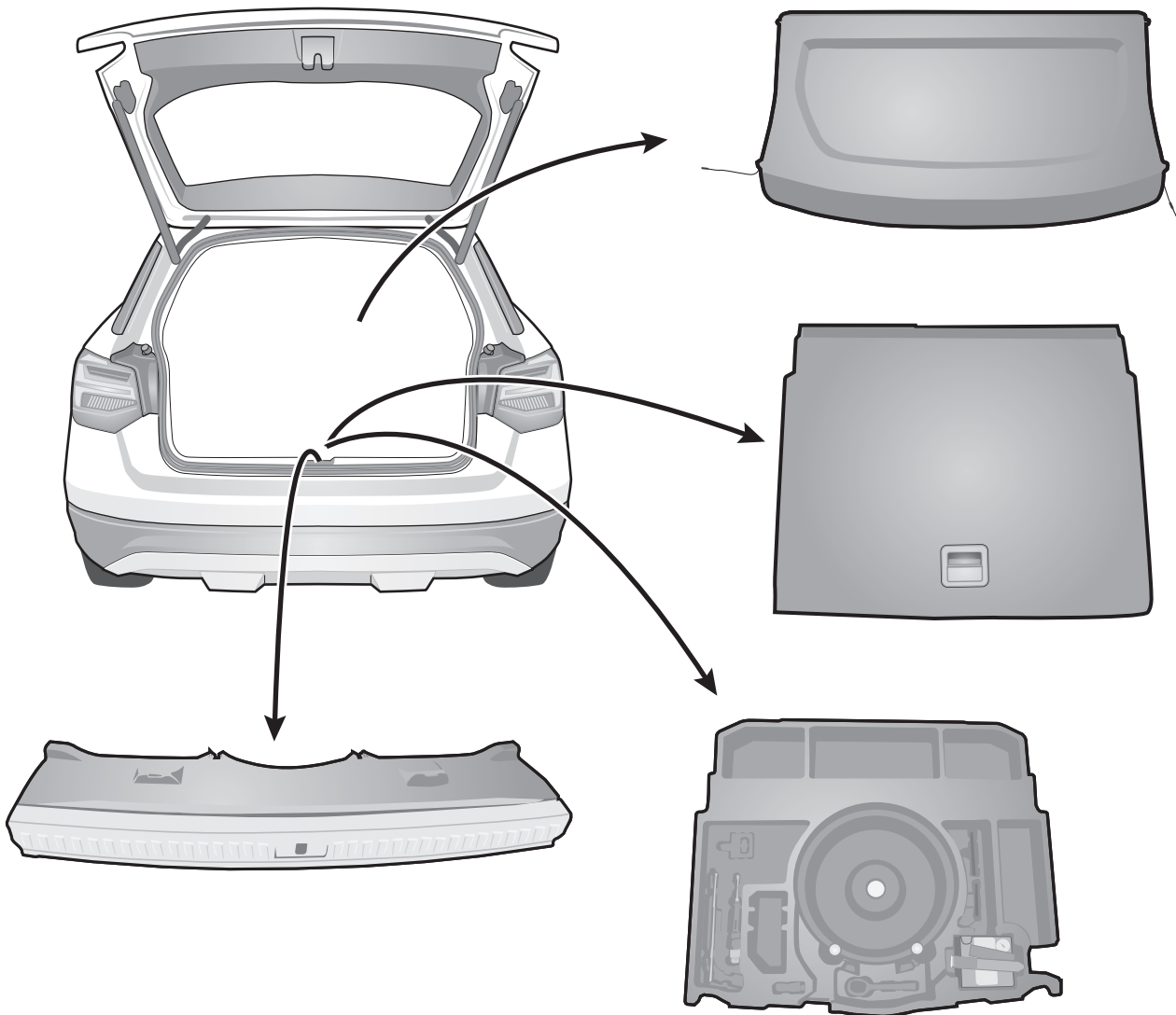

3

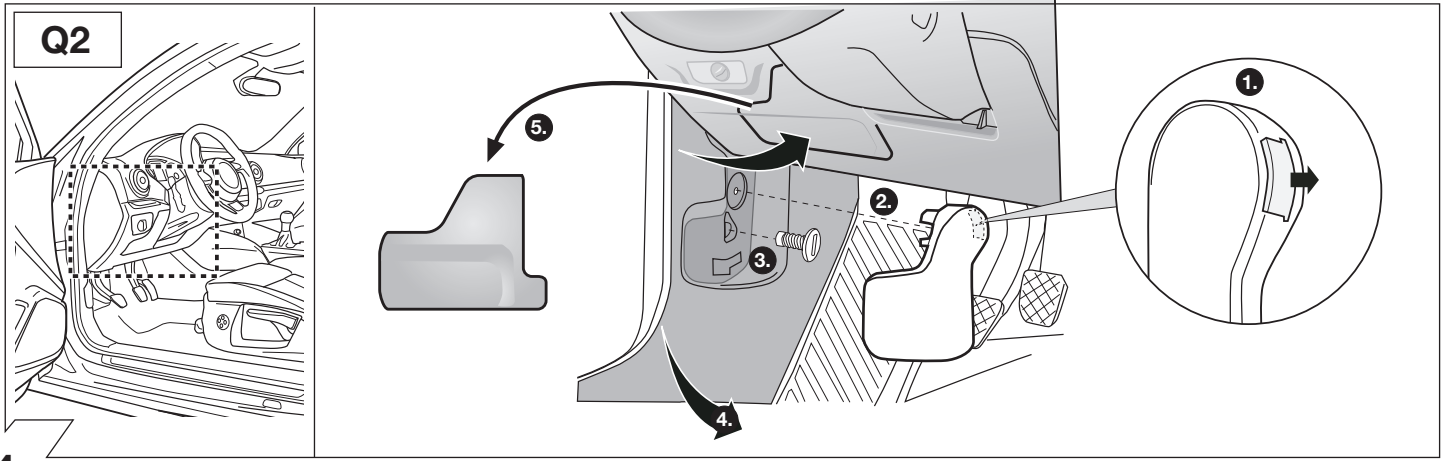

4

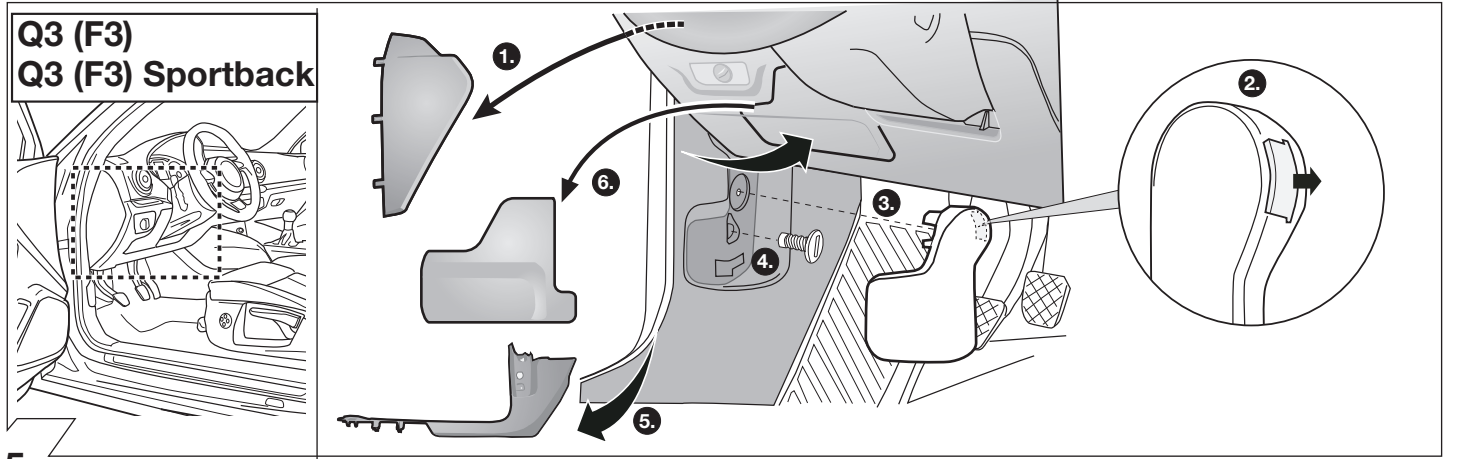

5

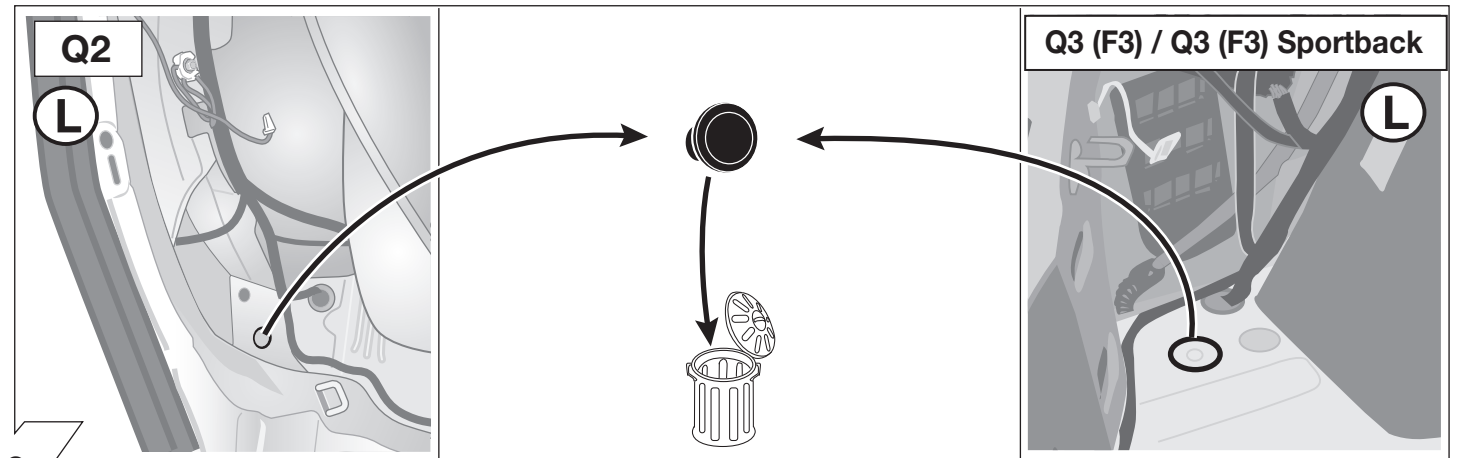

6

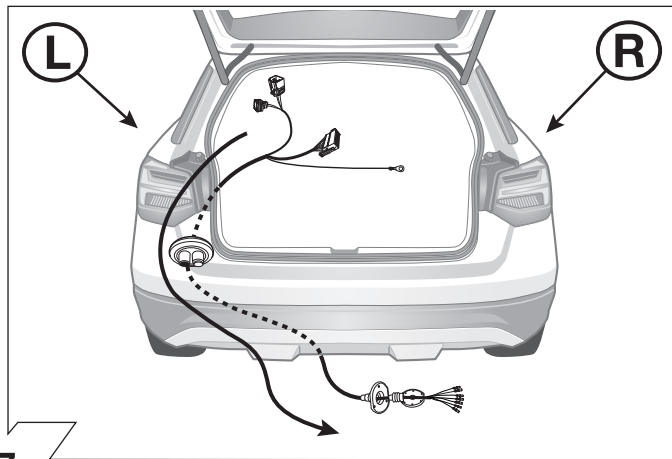

7

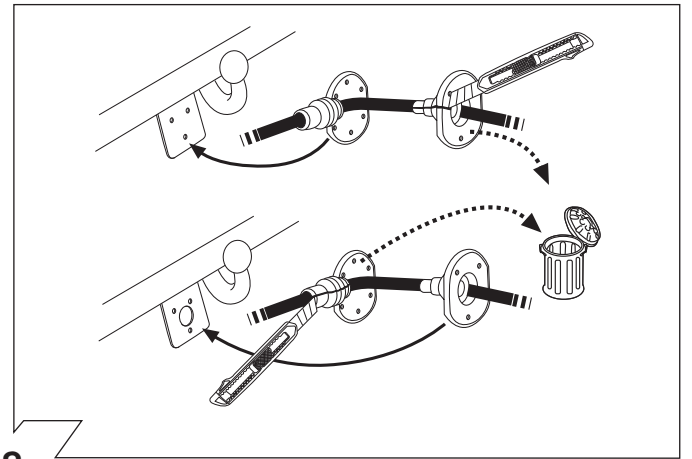

8

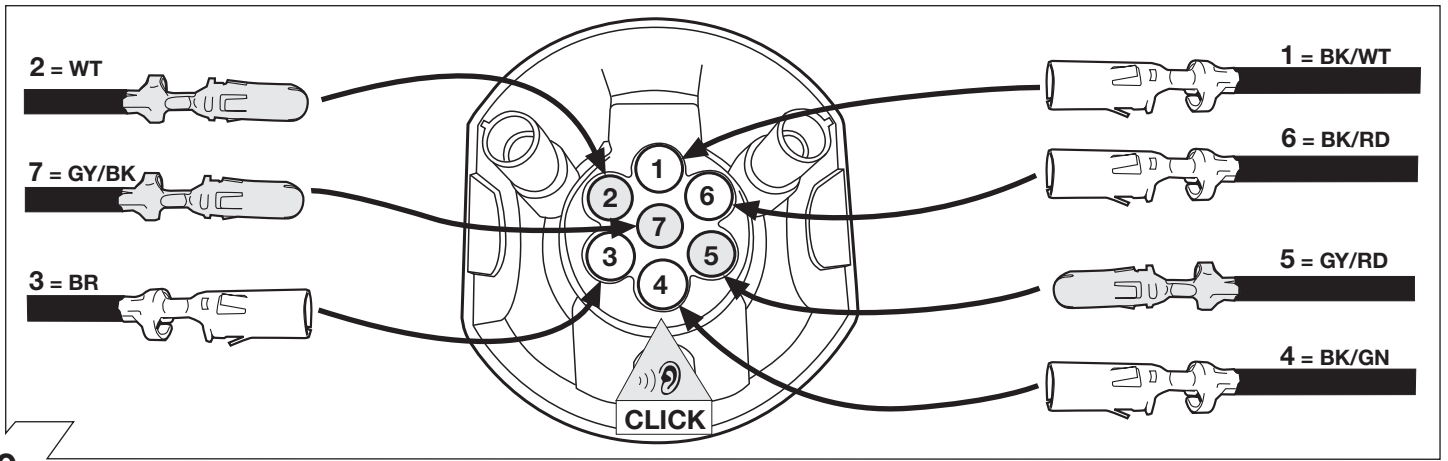

9

ISO 1724	Belegung der Steckdose / Maximale Ausgangsleistung Socket configuration / Maximum power output Correspondance des contacts de la prise / Puissance de sortie maximale Abbinamento della presa / Uscita di alimentazione massima Indeling van de stekkerdoos / maximaal uitgangsvermogen
	1/L BK/WT 21W
	2 WT 42W
	3/31 BR
	4/R BK/GN 21W
	5/58-R GY/RD 52W
	6/54 BK/RD 63W
	7/58-L GY/BK 52W

10

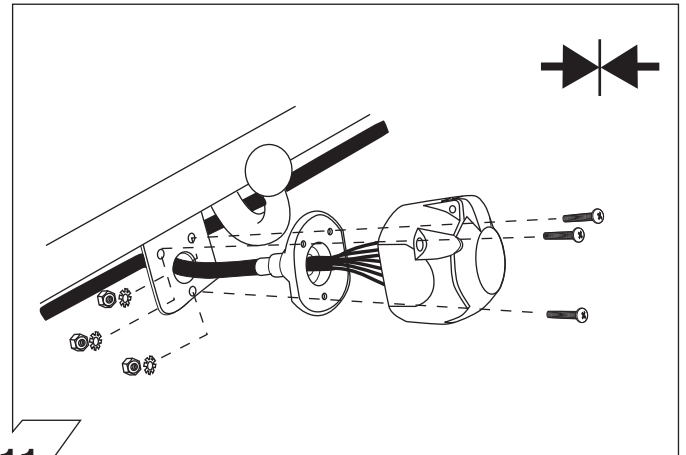

11

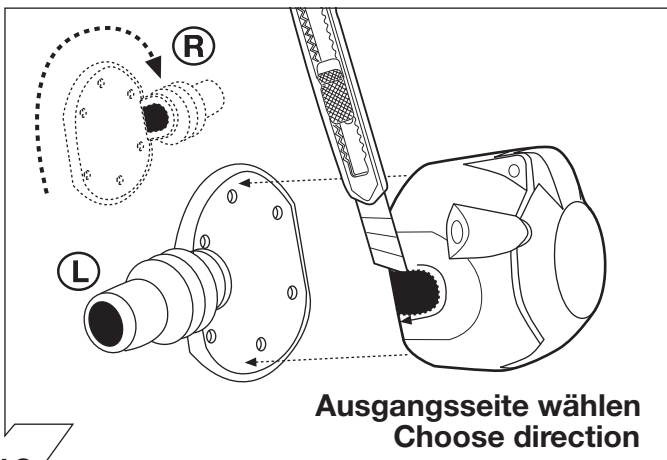

12

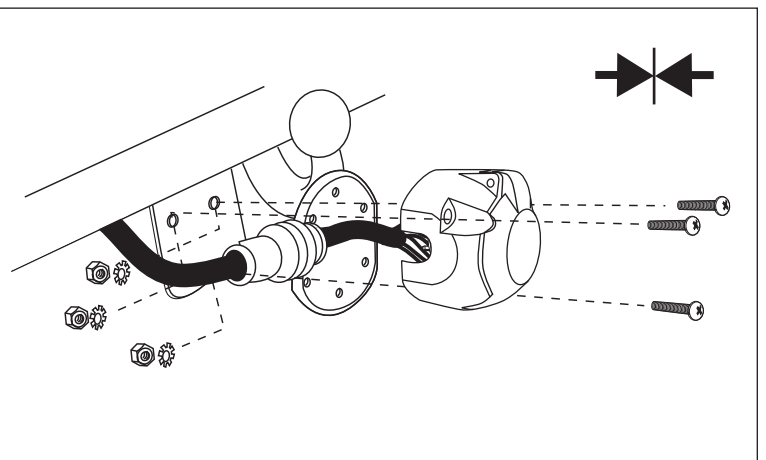

	GB	D	E	F	I	P	NL	DK	N	S	FIN	CZ	H	PL
BK	Black	Schwarz	Negro	Noir	Nero	Preto	Zwart	Sort	Svart	Svart	Musta	Černá	Fekete	Czarny
RD	Red	Rot	Rojo	Rouge	Rosso	Vermelho	Rood	Rød	Rød	Röd	Punainen	Červená	Piros	Czerwony
GN	Green	Grün	Verde	Vert	Verde	Verde	Groen	Grøn	Grønt	Grön	Vihreä	Zelená	Zöld	Zielony
OR	Orange	Orange	Naranja	Orange	Arancione	Laranja	Oranje	Orange	Orange	Orange	Oranssi	Oranzová	Narancs	Pomarańczowy
VT	Violet	Violett	Violeta	Violet	Viola	Violeta	Violet	Violet	Fiolett	Violett	Violetti	Fialová	Ibolya	Fioletowy
PK	Pink	Pink	Pink	Rose	Rosa	Cor-de-Rosa	Paars	Pink	Pink	Rosa	Pinkki	Růžová	Rózsaszín	Różowy
BL	Blue	Blau	Azul	Bleu	Blu	Azul	Blauw	Blå	Blått	Blå	Sininen	Modrá	Kék	Niebieski
YL	Yellow	Gelb	Amarillo	Jaune	Giallo	Amarelo	Geel	Gul	Gult	Gul	Keltainen	Zlutá	Sárga	Żółty
WT	White	Weiss	Blanco	Blanc	Bianco	Branco	Wit	Hvid	Hvitt	Vit	Valkoinen	Bílá	Fehér	Biały
BR	Brown	Braun	Marrón	Brun	Marrone	Marrom	Bruin	Brun	Brunt	Brun	Ruskea	Hnědá	Barna	Brazowy
GY	Grey	Grau	Gris	Gris	Grigio	Cinzeno	Grijs	Grå	Grått	Grå	Harmaa	Sedá	Szürke	Szary

13

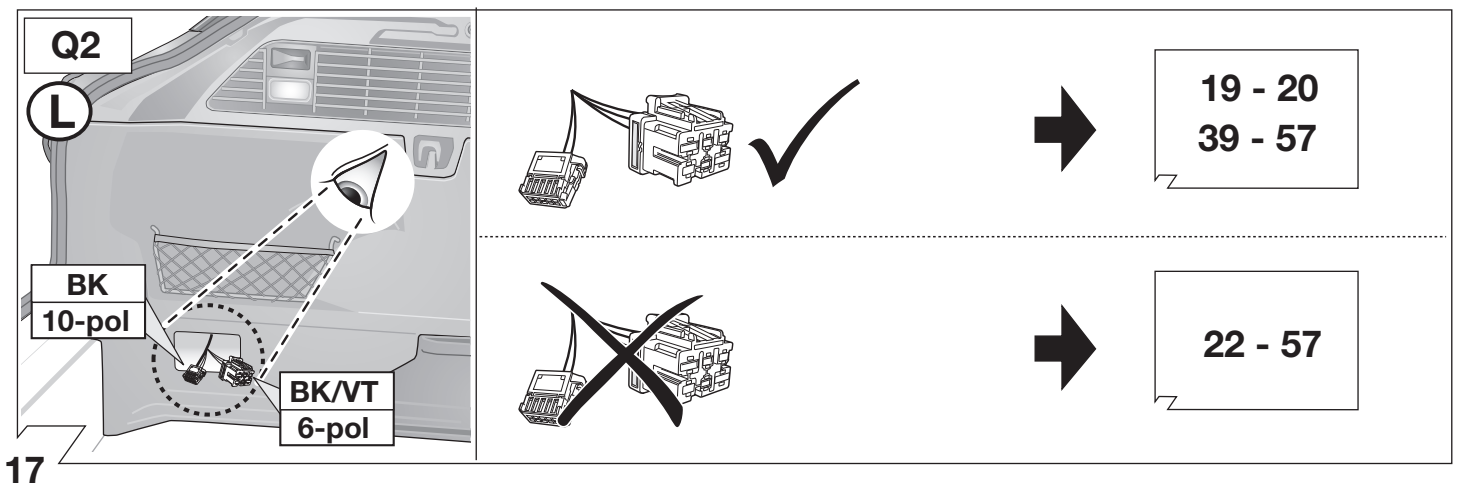
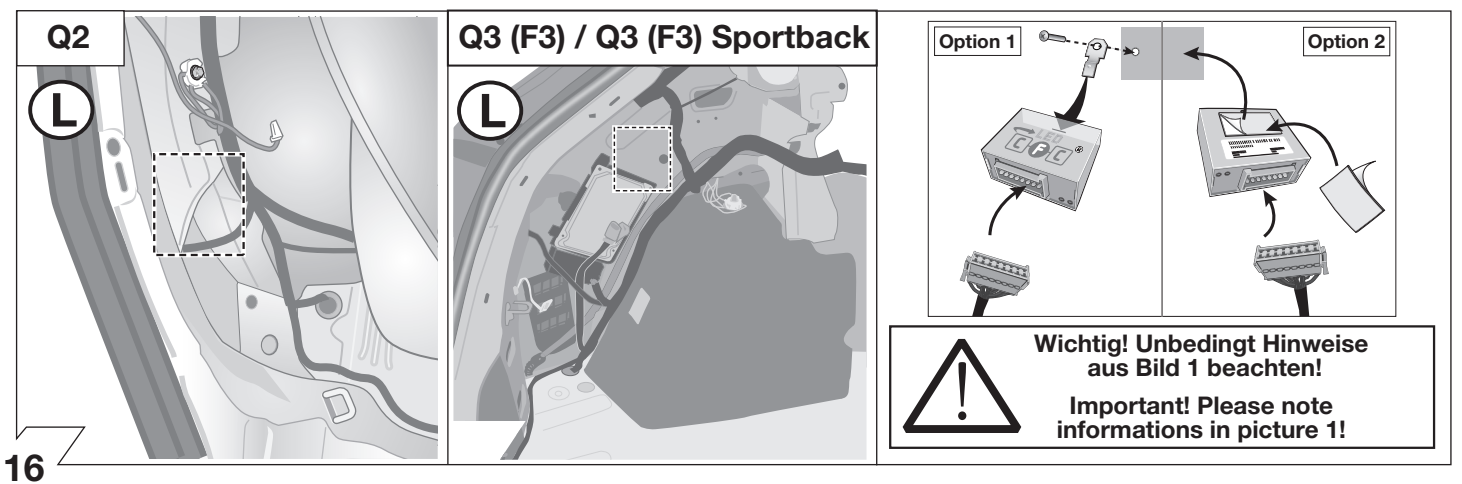
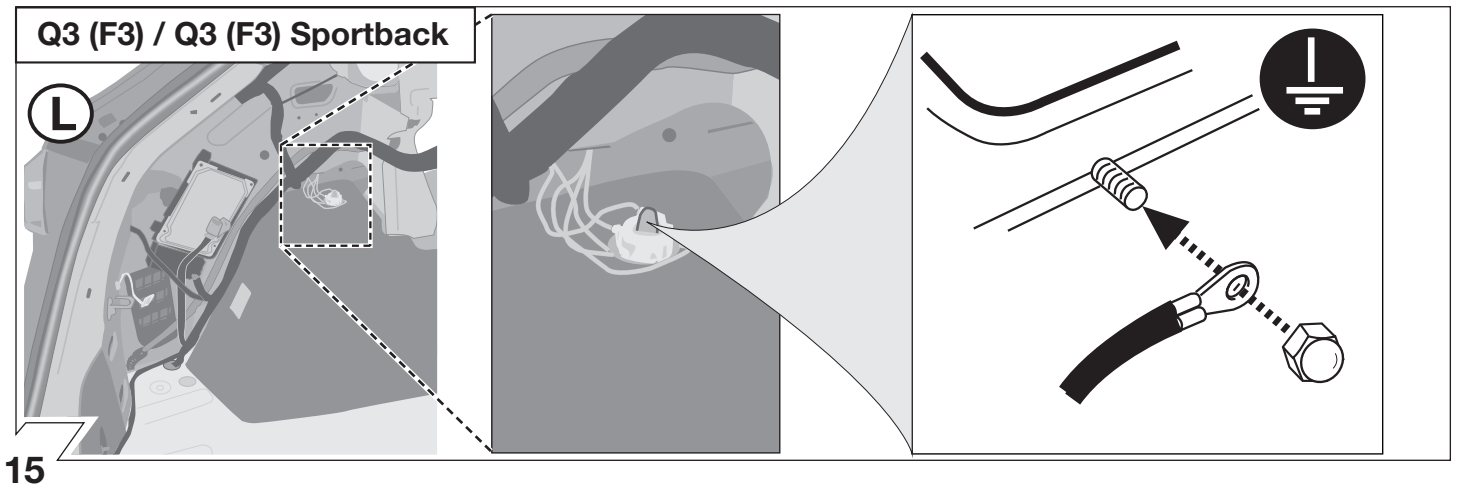
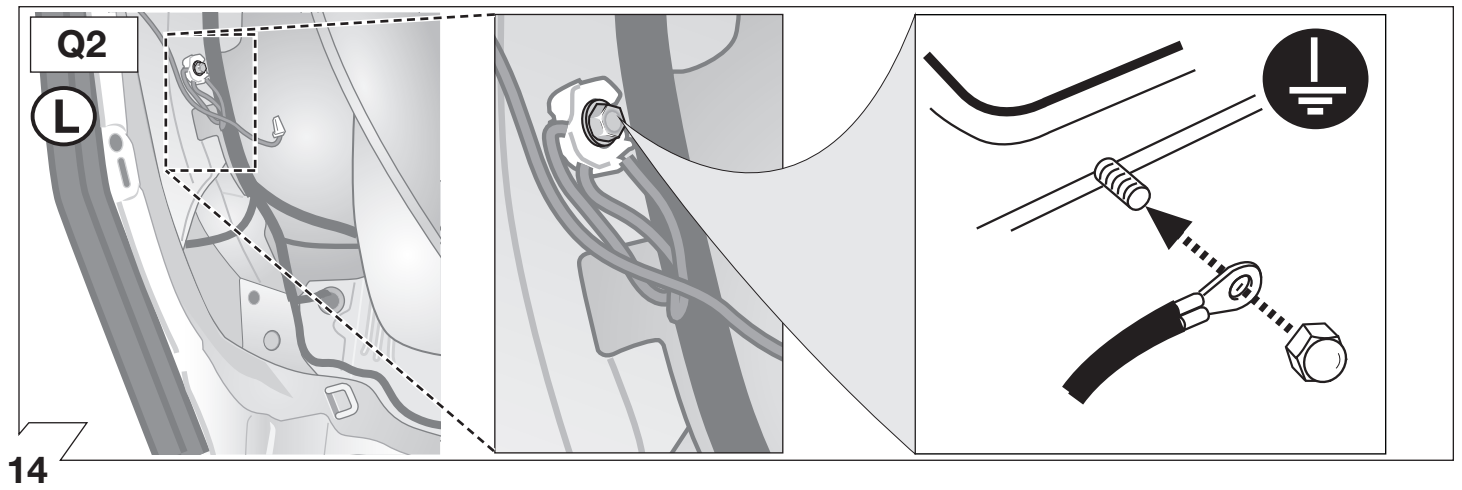

Q3 (F3) / Q3 (F3) Sportback

L

BK
10-pol

BK/VT
6-pol

→ **19 - 21**
39 - 57

→ **22 - 57**

18

BK/VT
6-pin

19

L

CAN-Stecker/CAN-Connector

BK / 2PIN

Wichtig!
Unbedingt Hinweise
aus Bild 1 beachten!

Important!
Please note
informations in
picture 1!

20

Q3 (F3)
Q3 (F3) Sportback

L

15A

20A

15A

21

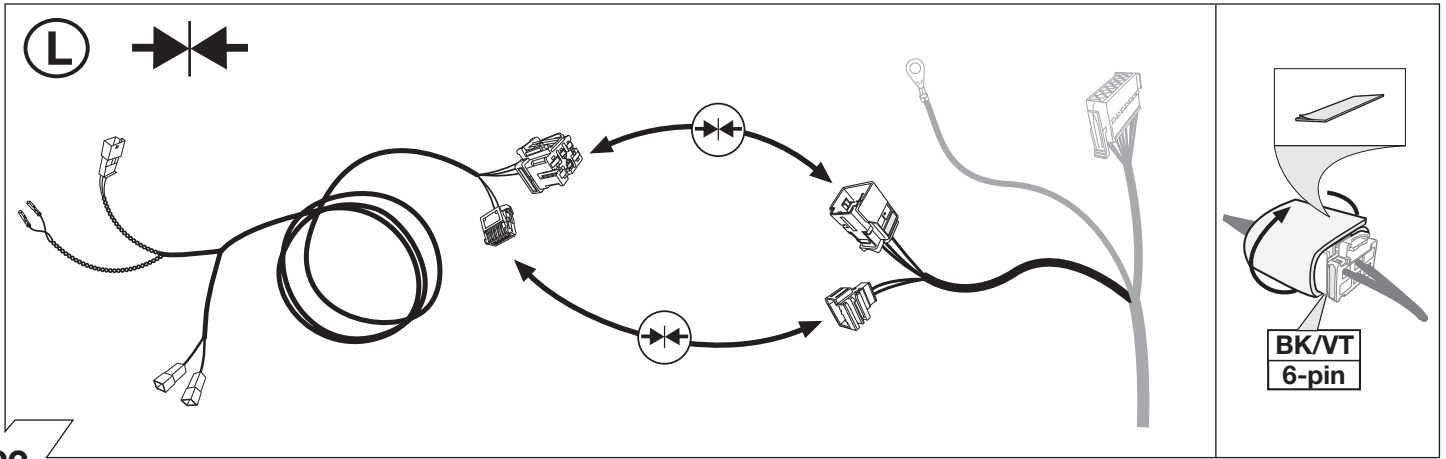

22

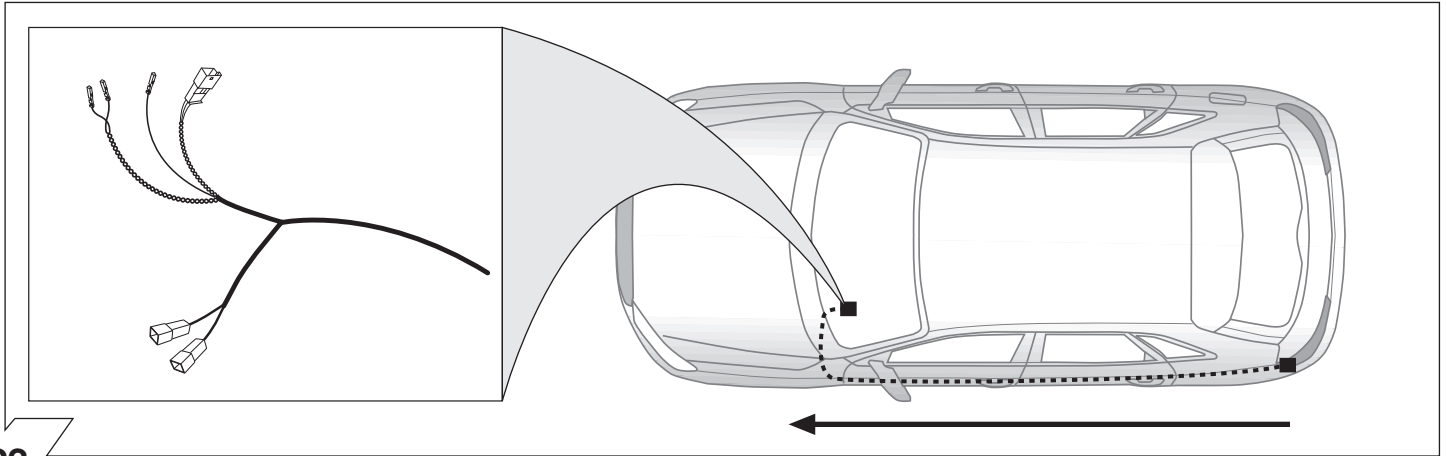

23

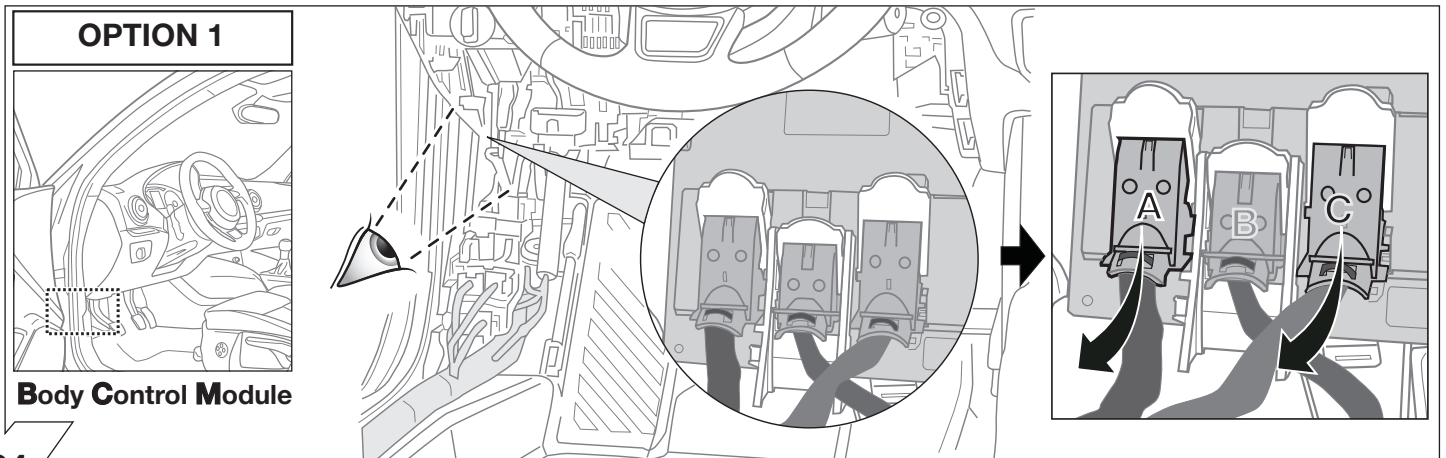

24

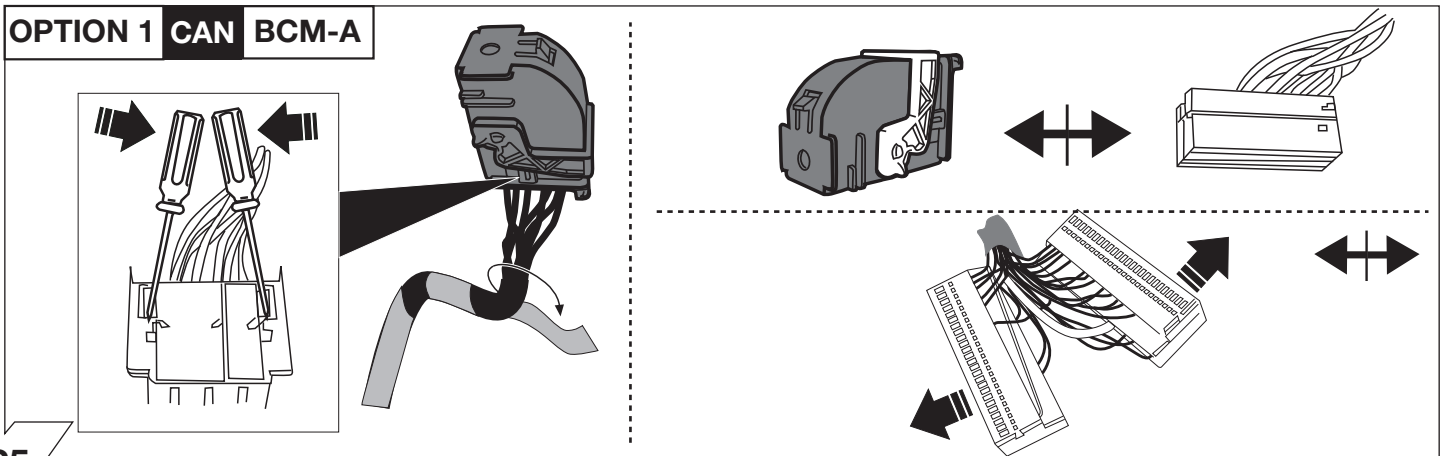

25

BCM-A

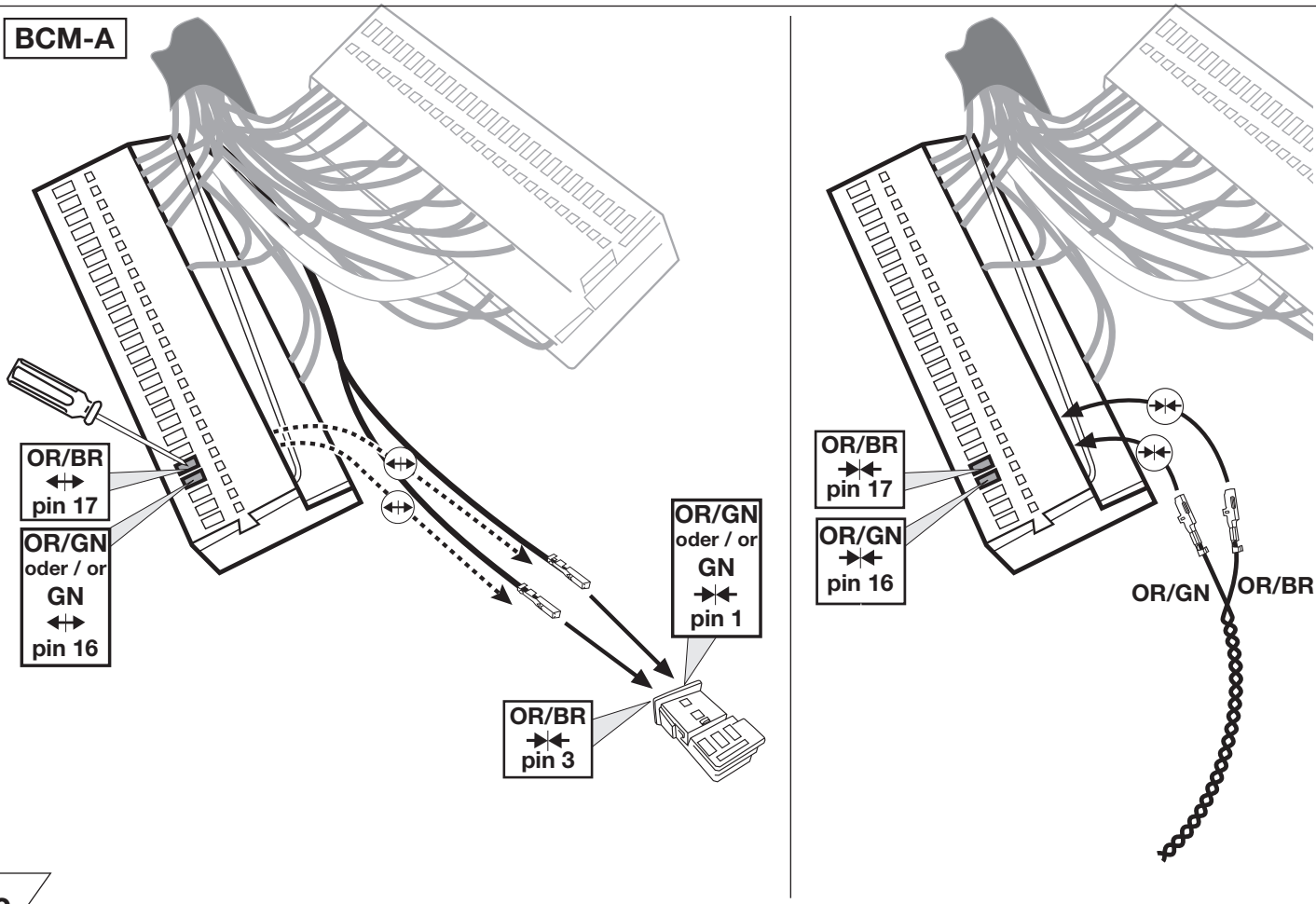

26

OPTION 1

BCM-C

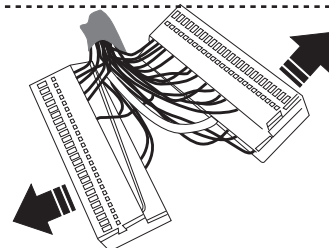
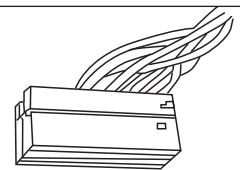
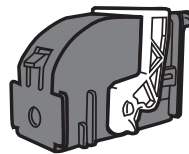
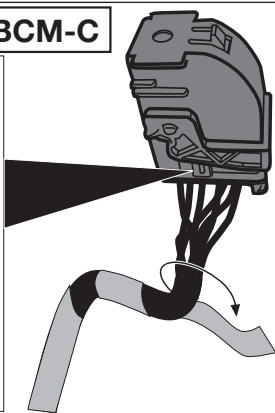
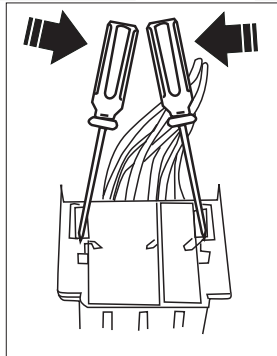

BCM-C

STOP BK/RD pin 58

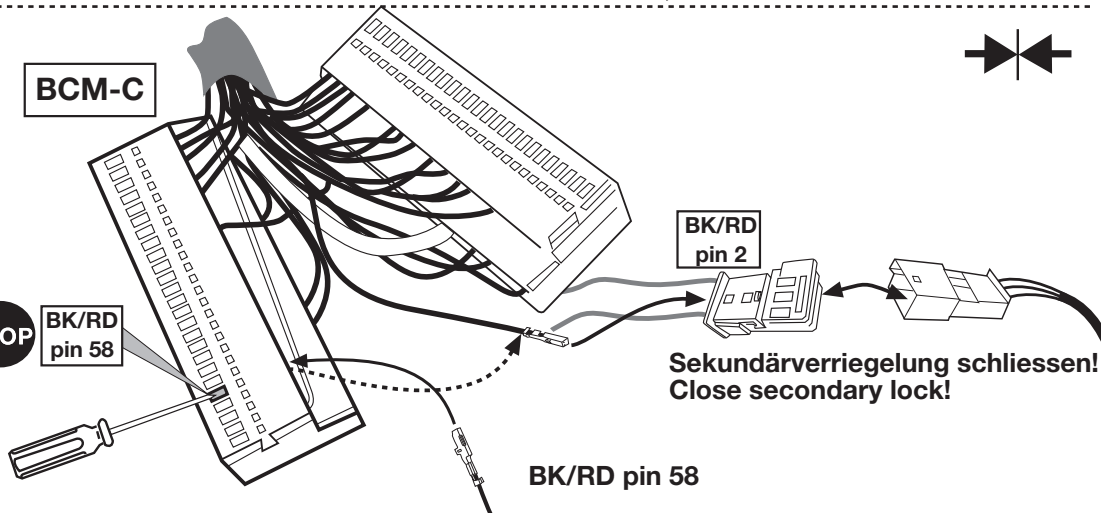

27

OPTION 2

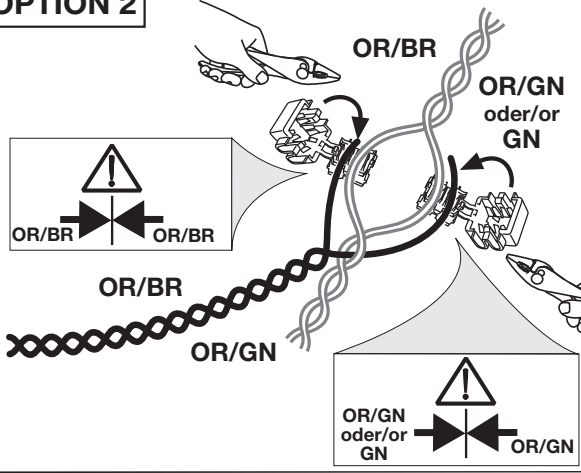

Wichtig!
Unbedingt Hinweise
aus Bild 1 beachten!

Important! Please
note informations
in picture 1!

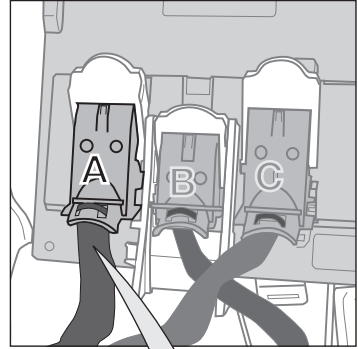

CAN-Data Wire

- OR/BR (Kammer/ chamber 17)
- OR/GN oder/or GN (Kammer / chamber 16)

**Bordnetzsteuergerät
Steckgehäuse A**
Network control unit
connector A

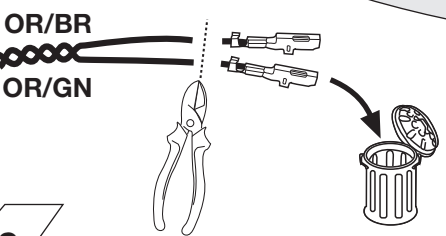
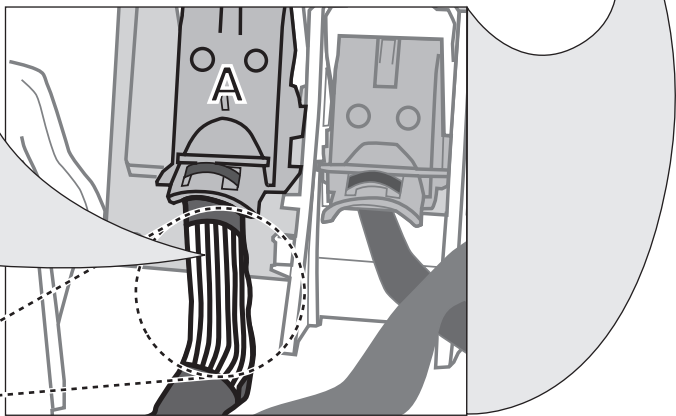

OPTION 2

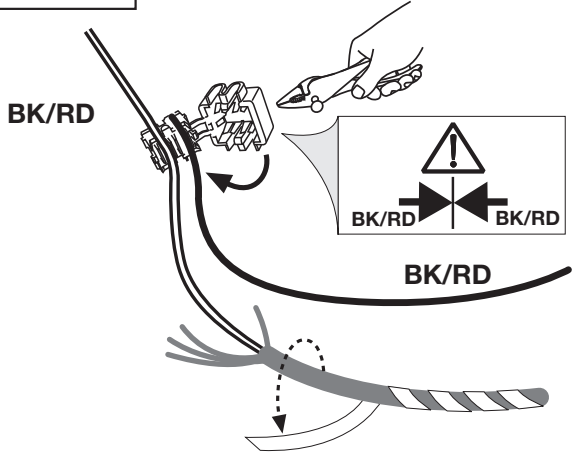

Wichtig!
Unbedingt Hinweise
aus Bild 1 beachten!

Important! Please
note informations
in picture 1!

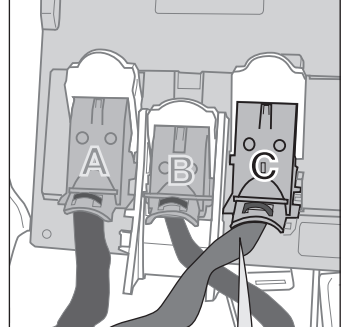

STOP BK/RD

BK/RD Kammer 58
BK/RD chamber 58

**Bordnetzsteuergerät
Steckgehäuse C**
Network control unit
connector C

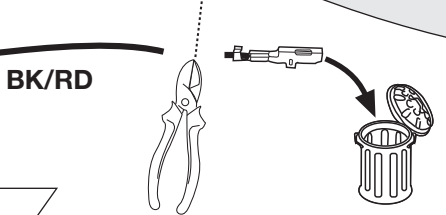
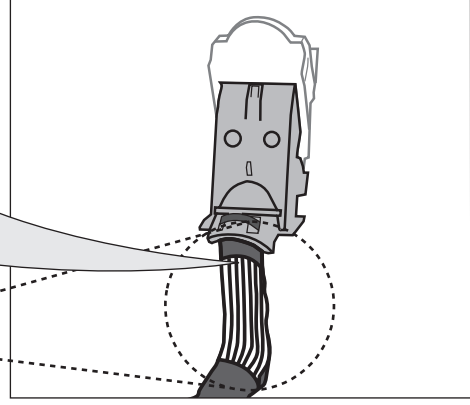

OPTION 2

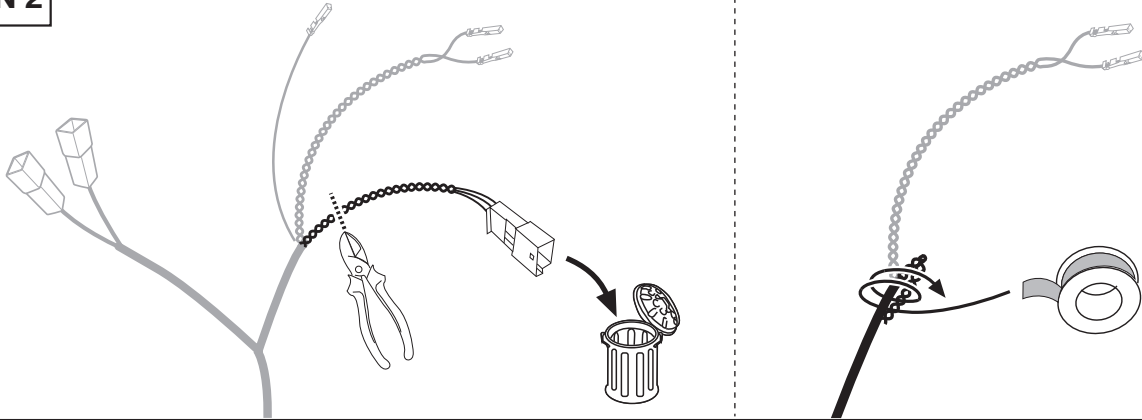

30

**B+/30
Option A**

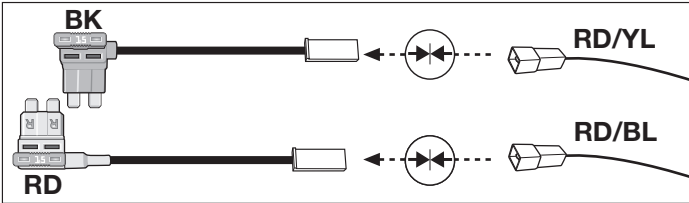

**32 - 33
34 - 57**

**B+/30
Option B**



35 - 57

31

OPTION A

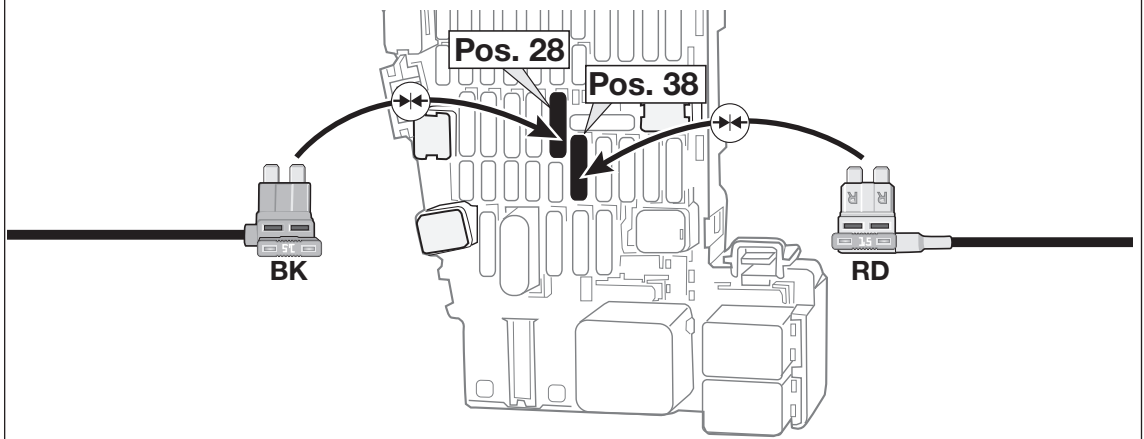
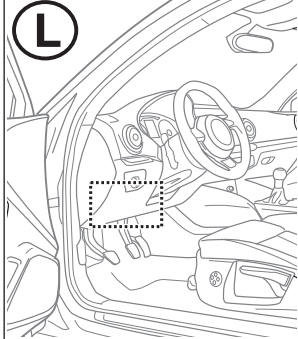

32

OPTION A

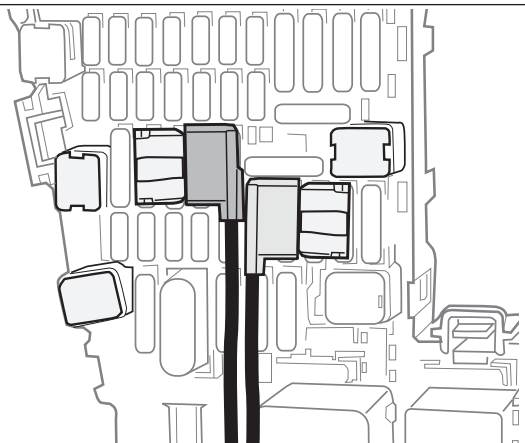
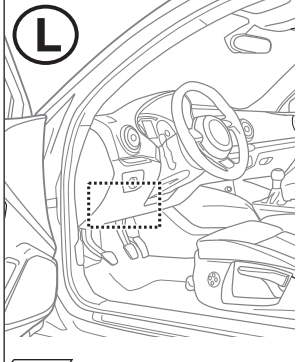





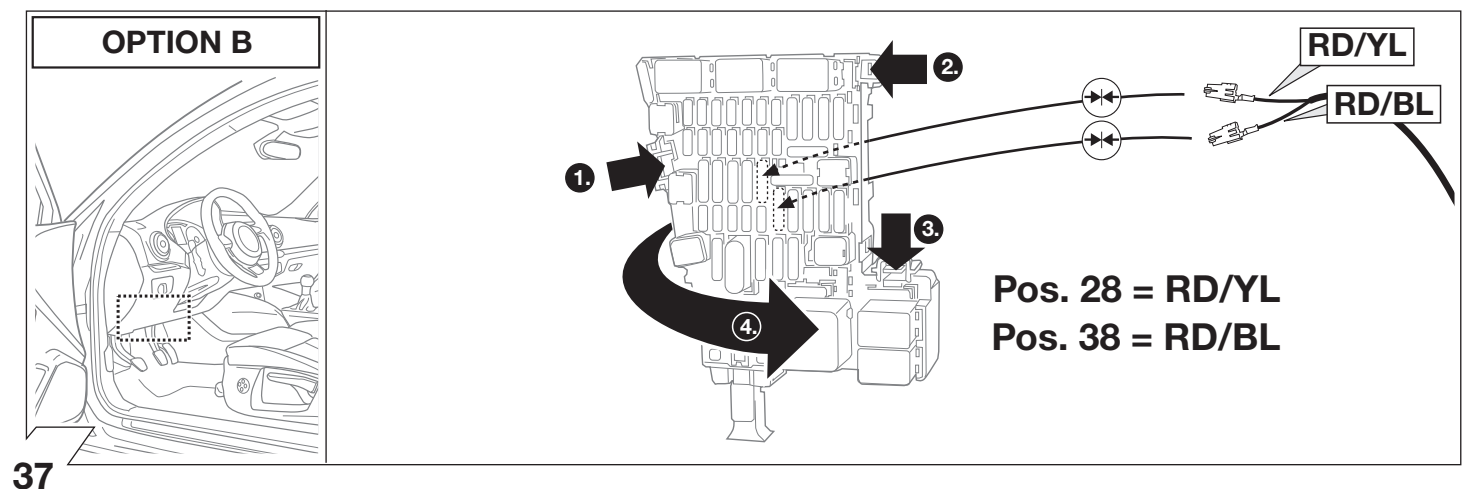
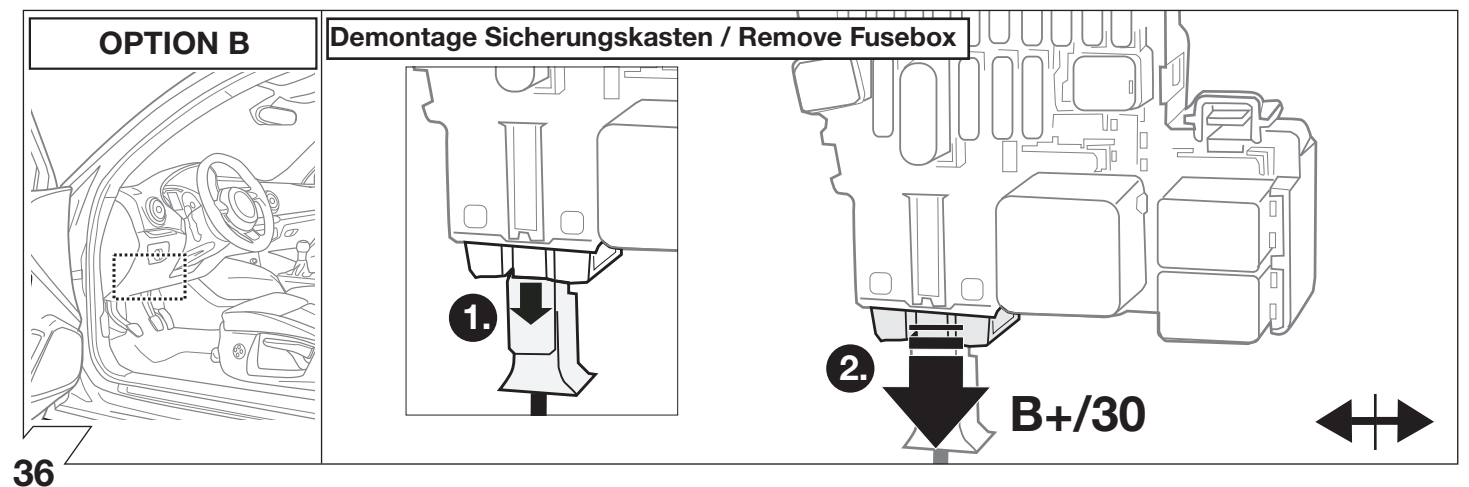
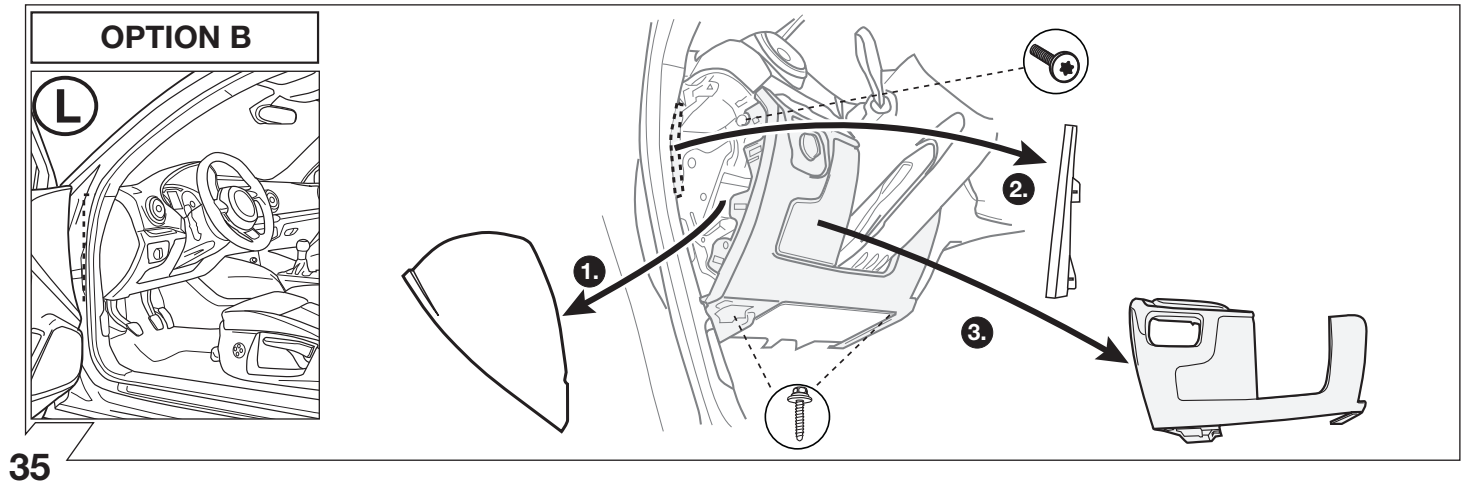
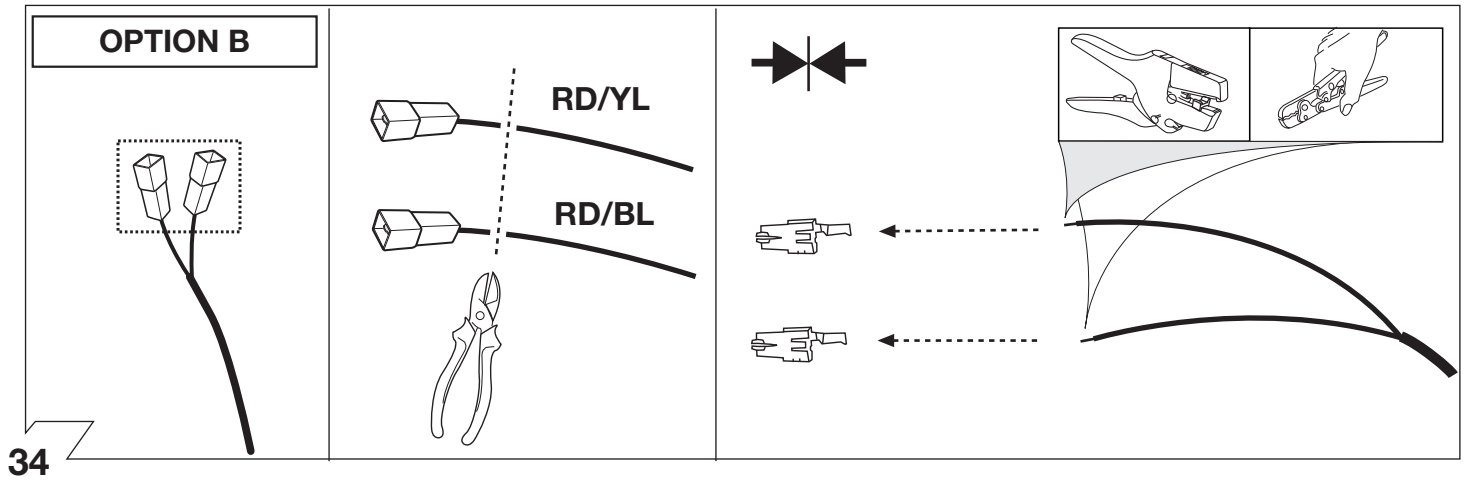

Wichtig!
Die Sicherungsbrücke darf nicht
in entgegengesetzter Richtung
eingebaut werden!

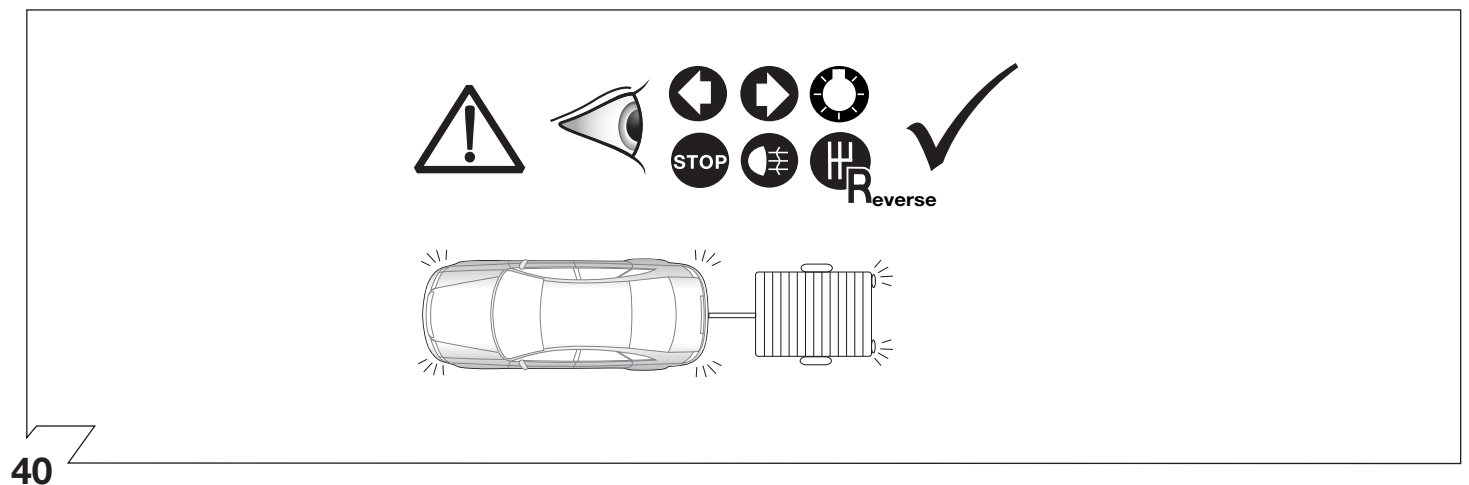
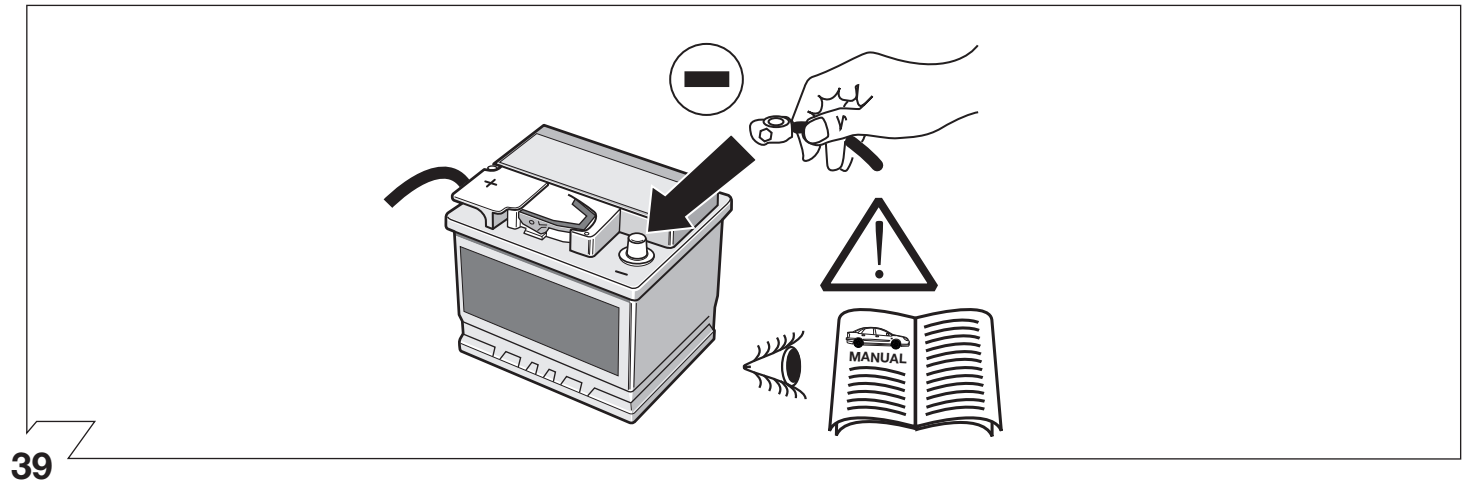
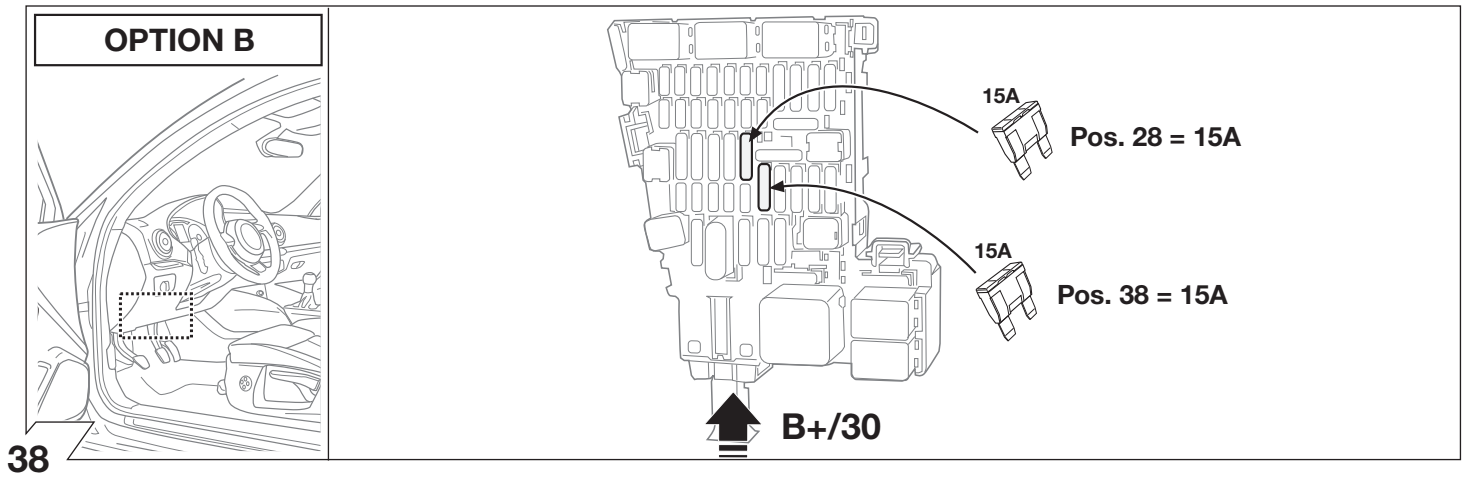
Important!
Please do not mount the fuse tap
and its wiring output in the other
direction!

33





 <p>Folgende Beleuchtungsfunktionen des Anhängers werden nicht bei allen Zugfahrzeugen mit Tagesfahrlichtschaltung unterstützt:</p> <ul style="list-style-type: none"> • Schlussleuchten • Begrenzungsleuchten • Kennzeichenbeleuchtung <p>Zur Aktivierung dieser Funktionen muss Stand- oder Abblendlicht eingeschaltet werden!</p> <p>(D)</p>	 <p>Le seguenti funzioni per l'illuminazione del rimorchio non sono supportate da tutte le motrici con circuito di luci diurne:</p> <ul style="list-style-type: none"> • luci posteriori • luci d'ingombro • illuminazione targa <p>Per attivare queste funzioni devono essere accese le luci di posizione o gli anabbaglianti!</p> <p>(I)</p>	 <p>De volgende verlichtingsfuncties van de aanhanger worden niet bij alle trekkende voertuigen met daglichtschakeling ondersteund:</p> <ul style="list-style-type: none"> • Achterlichten • Spatbordlampen • Kentekenverlichting <p>Ter activering van deze functies moet parkeer- of dimlicht worden ingeschakeld!</p> <p>(NL)</p>
 <p>The following light functions for the trailer are not supported by all towing vehicles with DRL circuit:</p> <ul style="list-style-type: none"> • Rear lights • Side lights • Numberplate lights <p>The taillights or dimmed headlights must be switched on to activate this function!</p> <p>(GB)</p>	 <p>Les fonctions d'éclairage suivantes de la remorque ne sont pas activables sur tous les véhicules de traction équipés de feux de circulation de jour:</p> <ul style="list-style-type: none"> • Feux arrière • Feux d'encombrement • Éclairage de la plaque minéralogique <p>Pour activer ces fonctions, les feux de position ou de croisement doivent être allumés!</p> <p>(F)</p>	 <p>No todos los vehículos tractores con conmutación de luz de marcha diurna ofrecen un soporte para las siguientes funciones de iluminación del remolque:</p> <ul style="list-style-type: none"> • Luces traseras • Luces de galíbo • Iluminación de la matrícula <p>¡Para activar estas funciones deberán encenderse las luces de posición o las luces de cruce!</p> <p>(E)</p>

41

OPTION 1



Codierung Steuergerät Seite 18-21
 Code Control unit page 18-21
 Codage dispositif de commande page 18-21
 Codifica dispositivo di controllo pagina 18-21
 Contralor de codificacion pagina 18-21
 Bedieningsapparaat coderen pagina 18-21

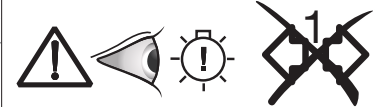
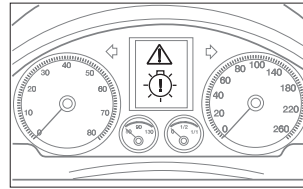
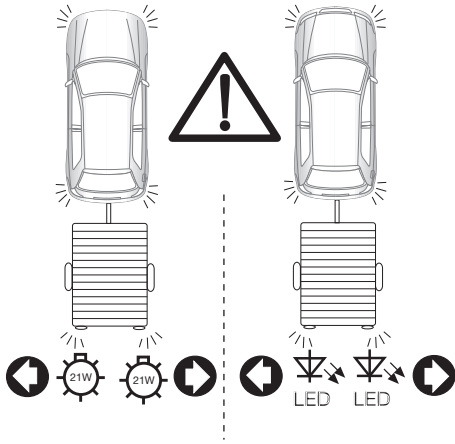
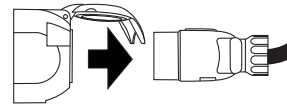
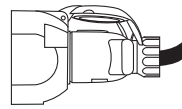

SETUP



1.



2.

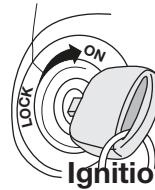

Ignition ON

3.

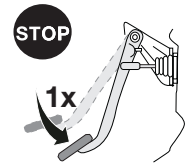

4.

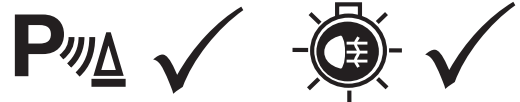

OPTION 2

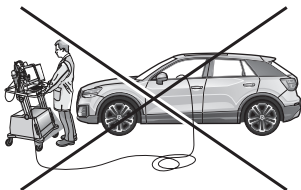

Seite 22
 page 22
 page 22
 pagina 22
 pagina 22
 pagina 22

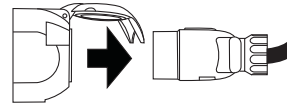
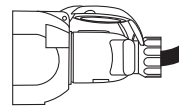

OPTIONAL

Trailer Simulator for 7- and 13-pin Sockets

Part-no. 765069



44

Optional: Adapter socket 768019

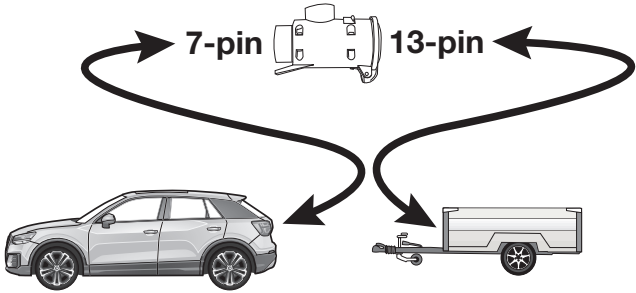

45

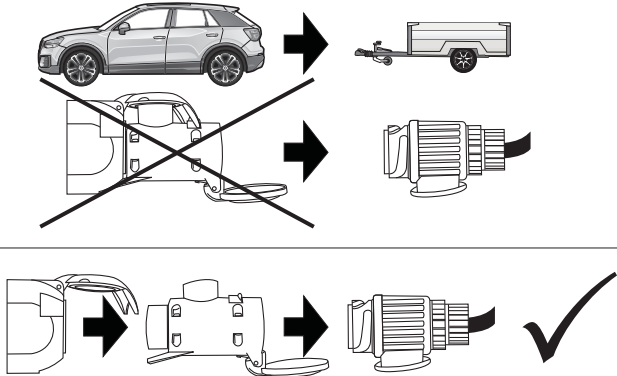

The diagram shows two scenarios. The top scenario shows a car connected to a trailer, which is then connected to a 7-pin socket. This is crossed out with a large 'X', indicating it is incorrect. The bottom scenario shows a hand plugging a 7-pin socket into a car's port, which is then connected to a 13-pin socket. This is marked with a checkmark, indicating it is the correct method.

46

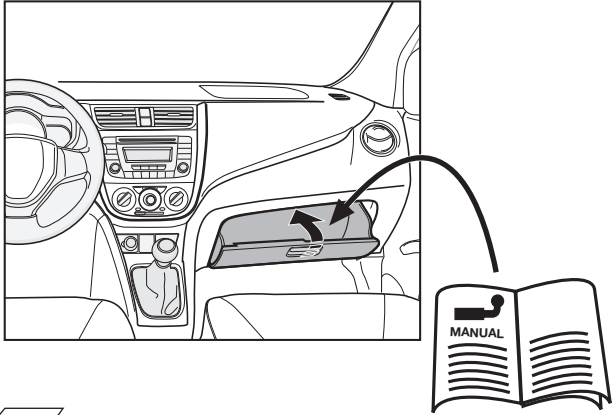

The diagram shows the interior of a car, with an arrow pointing to the glove compartment area where the trailer simulator is located. A manual icon is shown next to it.

47

Anhängerbetrieb konfigurieren / Set up trailer operation

OPTION 1

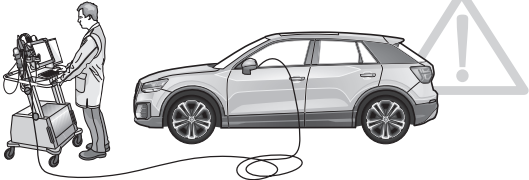

D	GB	F
<p>→ Diagnosedienstleister bzw. Diagnosemethoden (lokal/offline):</p> <ul style="list-style-type: none"> • Hella Gutmann (→ Seite 18) • VCDS (→ Seite 19-20) • Autologic • Bosch / KTS • SP Diagnostic • SUN • etc. pp. 	<p>→ Diagnosis Services or diagnostic methods (local / offline):</p> <ul style="list-style-type: none"> • Hella Gutmann (→ page 18) • VCDS (→ Seite 19-20) • Autologic • Bosch / KTS • SP Diagnostic • SUN • etc. pp. 	<p>→ Diagnostic services ou les méthodes de diagnostic (local / hors ligne):</p> <ul style="list-style-type: none"> • Hella Gutmann (→ page 18) • VCDS (→ Seite 19-20) • Autologic • Bosch / KTS • SP Diagnostic • SUN • etc. pp.
I	E	NL
<p>→ Alternativa Diagnosi Servizio o metodi diagnostici (locale / offline):</p> <ul style="list-style-type: none"> • Hella Gutmann (→ pagina 18) • VCDS (→ pagina 19-20) • Autologic • Bosch / KTS • SP Diagnostic • SUN • etc. pp. 	<p>→ Servicio de Diagnóstico Alternativa o métodos de diagnóstico (locales / fuera de línea):</p> <ul style="list-style-type: none"> • Hella Gutmann (→ pagina 18) • VCDS (→ pagina 19-20) • Autologic • Bosch / KTS • SP Diagnostic • SUN • etc. pp. 	<p>→ Alternatief Diagnose Dienst of diagnostische methoden (lokale / offline):</p> <ul style="list-style-type: none"> • Hella Gutmann (→ pagina 18) • VCDS (→ pagina 19-20) • Autologic • Bosch / KTS • SP Diagnostic • SUN • etc. pp.

48

OPTION 1



S O L U T I O N S

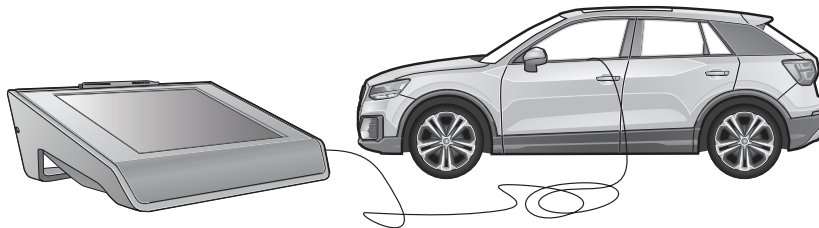

D

Die Aktivierung der Anhängerfunktionen muss wie folgt durchgeführt werden:

1. Fahrzeugauswahl
2. In Diagnose wechseln - Codierung
3. Anhängerkupplung de-/aktivieren
4. Diagnose Interface Bus auswählen
5. Anleitung folgen

Fahrzeuge mit Assistenzsystemen

6. AHK an Assistenzsysteme anpassen ausführen
7. Anleitung folgen
8. Diagnose
9. Fehlerspeicher auslesen, ggf. löschen
10. Fertig

GB

The activation of the trailer functions must be performed as follows:

1. Vehicle selection
2. switch to diagnostics - coding
3. Deactivate/activate trailer coupling
4. Select diagnostic Interface Bus
5. Follow instructions

Vehicles with assistance systems

6. Perform adaptation of trailer coupling on assistance systems
7. Follow instructions
8. Diagnostics
9. Read out error memory, delete if necessary
10. Done

F

Pour activer l'attelage, procéder de la façon suivante :

1. Choix véhicule
2. Aller dans le diagnostic - codage
3. Activer/désactiver le diagnostic
4. Sélectionner le BUS d'interface de diagnostic
5. Suivre les instructions

Véhicules avec systèmes d'aide

6. Effectuer une adaptation d'attelage aux systèmes d'aide
7. Suivre les instructions
8. Diagnostic
9. Lire la mémoire de défaut et effacer les codes d'erreur éventuellement mémorisés
10. Terminé

I

Per attivare le funzioni del rimorchio, procedere nel modo seguente:

1. Scelta vettura
2. Passare alla >Diagnosi< - Codifica
3. Attivare / disattivare il gancio di traino
4. Selezionare il interfaccia di diagnosi
5. Seguire le istruzioni

Veicoli con sistemi di assistenza

6. Adattare i sistemi installati
7. Seguire le istruzioni
8. Diagnosi
9. Leggere la memoria guasti e cancellare, se necessario
10. Terminato

E

La activación de las funciones de remolque debe realizarse de la siguiente manera:

1. Selección de vehículo
2. Cambiar a diagnosis - Codificación
3. Desactivar/activar acoplamiento para remolque
4. Seleccionar diagnosis Interface Bus
5. Seguir las instrucciones

En vehículos con sistemas de asistencia

6. Ejecutar adaptación de acoplamiento para remolque a sistemas de asistencia
7. Seguir las instrucciones
8. Diagnosi
9. Leer memoria de averías y borrarla si es necesario
10. Listo

NL

De activering van de aanhangerfuncties moet als volgt worden uitgevoerd.:

1. Voertuigselectie
2. Ga naar Diagnose - Codering
3. Aanhangwagenkoppeling deactiveren/activeren
4. Diagnose interface bus selecteren
5. Volg instructie op

Bij voertuigen met assistentiesystemen

6. "Aanhangwagenkoppeling aanpassen aan assistentiesystemen" uitvoeren
7. Volg instructie op
8. Diagnose
9. Foutcodegeheugen uitlezen en indien nodig wissen
10. Gereed

OPTION 1

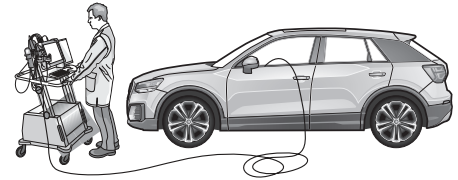

D

Codierung VW/Audi/Seat/Skoda mit VCDS

Bitte beachten :

Der nachfolgend beschriebene Ablauf zur Codierung bzw. Freischaltung auf Anhängerbetrieb dient lediglich zur allgemeinen Orientierung und kann je nach Modell (Motorisierung/ Ausstattung) stark variieren. Gegebenenfalls müssen weniger oder noch weitere Steuergeräte angepasst werden.

- **Codierung Gateway_19 (Diagnoseinterface)**
Verbauliste ->
69 Anhänger -> verbaut
- **Codierung EZE_09 (Elektronisches Zentralelektrik-Steuergerät):**
Zugriffsberechtigung: 31347
Anpassung -10
Anpassungskanal:
Vernetzung
Anhängeranschlussgerät -> verbaut
Trailer Hitch Control Module -> verbaut
- **Codierung DIS_13 (Distanzregelung)**
Zugriffsberechtigung: 20103
Codierung
Control Module for Trailer -> verbaut
- **Codierung ZKS_46 (Zentralmodul Komfortsystem)**
Trailer control unit -> verbaut
- **Codierung SWA_3C (Spurwechselassistent)**
Trailer control unit -> verbaut
- **Codierung SCH_17 (Schalttafeleinsatz)**
Trailer control unit -> verbaut
- **Codierung RFK_6C (Rückfahrkamerasystem)**
Anhängererkennung -> verbaut
- **Codierung STF_74 (Fahrwerkssteuerung)**
Anhänger -> verbaut
- **Codierung EPH_10 (Einparkhilfe Steuergerät)**
Anhänger -> Anhängervorrichtung manuell abnehmbar
- **Codierung FFF_A5 (Frontsensorik Steuergerät)**
Anhängerelektronik -> verbaut
- **Codierung HDE_6D (Heckdeckelelektronik Steuergerät)**
Steuergerät für Anhänger -> verbaut

Wichtiger Hinweis zur Codierung bzw. Freischaltung auf Anhängerbetrieb.

Die vorab genannten Einstellungen werden im Bordnetz des Fahrzeuges vorgenommen und lokal abgespeichert. Bei generellen Updates der Fahrzeugsoftware (beispielsweise im Rahmen von Service- oder Instandsetzungsarbeiten), können diese Einstellungen unter Umständen wieder überschrieben und gelöscht werden. In diesem Fall muss die Freischaltung auf Anhängerbetrieb nach dem Update noch einmal lokal aktualisiert werden.

GB

Encoding VW/Audi/Seat/Skoda with VCDS

Please note :

The procedure described below for encoding and enabling the trailer mode only serves for a general orientation and can vary greatly depending on the model (motorisation / equipment). If necessary, fewer or further control units will have to be adapted.

- **Encoding Gateway_19**
Installations List ->
69 Trailer hitch control module -> installed
- **Encoding EZE_09 (electronic central electric controller):**
Access authorisation: 31347
Adaptation -10
Adaptation channel:
networking trailer connection device -> installed
Trailer hitch control module -> installed
- **Encoding DIS_13 (distance control)**
Access authorisation 20103
Encoding
Control module for trailer -> installed
- **Encoding ZKS_46 (central module comfort system)**
Trailer control unit -> installed
- **Encoding SWA_3C (lane change assistant)**
Trailer control unit -> installed
- **Encoding SCH_17 (control panel insert)**
Trailer control unit -> installed
- **Encoding RFK_6C (reversing camera system)**
Trailer detection -> installed
- **Encoding STF_74 (chassis control)**
Trailer -> installed
- **Encoding EPH_10 (PDC controller)**
Trailer -> Trailer device can be removed manually
- **Encoding FFF_A5 (front sensor system controller)**
Trailer electronics -> installed
- **Encoding HDE_6D (boot lid electronics controller)**
Controller for trailer -> installed

Important note on encoding and activating in trailer mode.

The aforementioned settings are carried out in the vehicle's electrical system and saved locally. During general updates for the vehicle software (for example, within the scope of service or repair work), the settings may be overwritten and deleted under certain circumstances. In this case, the trailer mode activation has to be updated again locally after the update.

F

Codage VW/Audi/Seat/Skoda avec VCDS

Attention :

Le déroulement du codage et de l'activation du fonctionnement avec remorque décrit ci-après sert uniquement d'information générale et peut varier fortement d'un modèle à l'autre (motorisation / équipement). Le cas échéant, il faudra ajuster moins ou au contraire plus d'appareils de commande.

- **Codage Gateway_19**
Installations List ->
69 Trailer hitch control module -> monté
- **Codage EZE_09 (appareil de commande électronique de la centrale électrique):**
Autorisation d'accès: 31347
Ajustement -10
Canal d'ajustement:
mise en réseau de l'appareil de connexion de la remorque montée
Trailer Hitch Control Module -> monté
- **Codage DIS_13 (réglage de la distance)**
Autorisation d'accès 20103
Codage
Control Modul for Trailer -> monté
- **Codage ZKS_46 (module central système confort)**
Trailer control unit -> monté
- **Codage SWA_3C (assistant de changement de file)**
Trailer control unit -> monté
- **Codage SCH_17 (porte-instruments)**
Trailer control unit -> monté
- **Codage RFK_6C (système de caméra de marche arrière)**
Identification de la remorque -> montée
- **Codage STF_74 (commande du châssis)**
Remorque -> montée
- **Codage EPH_10 (appareil de commande aide au stationnement)**
Remorque -> Dispositif de remorque démontable à la main
- **Codage FFF_A5 (appareil de commande capteurs avant)**
Électronique de la remorque -> montée
- **Codage HDE_6D (appareil de commande de l'électronique du hayon)**
Appareil de commande pour débutants -> monté

Remarque importante sur le codage et l'activation du fonctionnement avec remorque.

Les réglages mentionnés ci-dessus sont effectués dans le réseau de bord du véhicule et sauvegardés localement. Pour les mises à jour générales du logiciel du véhicule (par exemple dans le cadre de travaux d'entretien ou de réparation), ces réglages peuvent dans certains cas être écrasés et supprimés. Dans ce cas, l'activation du fonctionnement avec remorque doit être encore une fois actualisée localement après la.

OPTION 2



52

OPTION 2

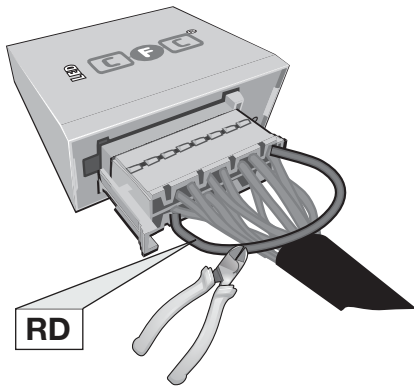

Pin 11 and Pin 2 disconnected
Pin 11 and Pin 2 unterbrochen

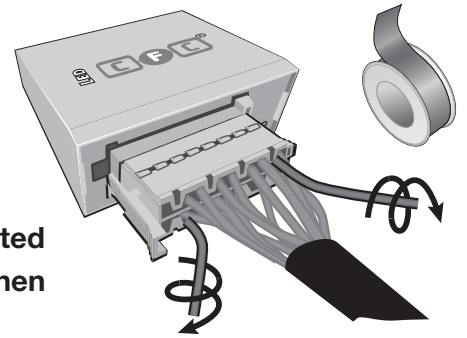

53

OPTION 2

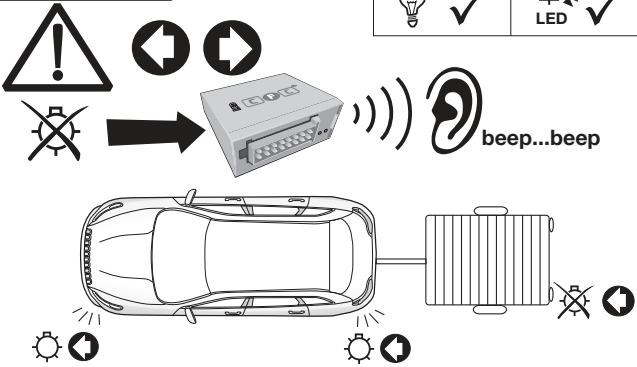

54

OPTION 2

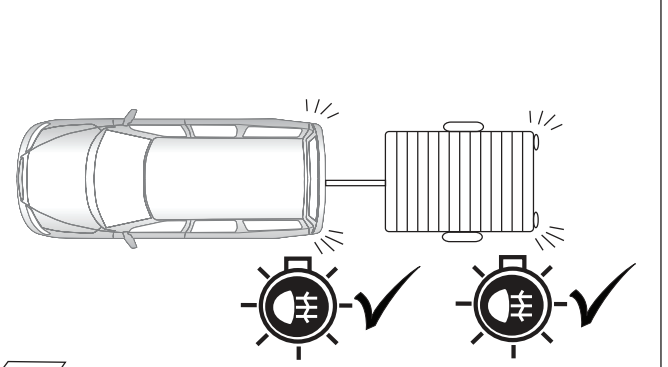

55

OPTION 2

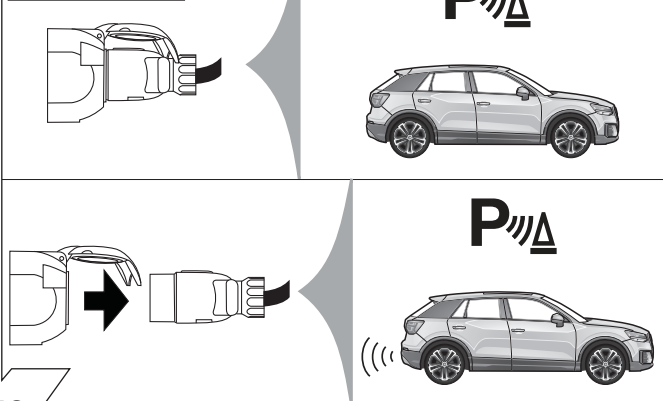





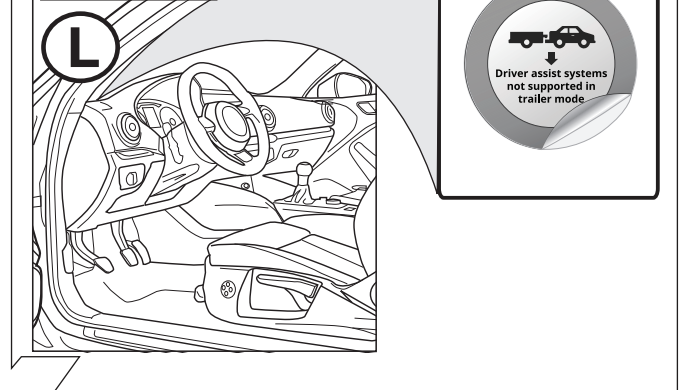























56

OPTION 2



57

D Diagnosefunktion der Kontroll-LED's	GB Diagnosis function of control LEDs	F Fonction diagnostic des LED de contrôle
I Funzione di diagnostica dei LED di controllo	E Función de diagnóstico de los LEDs de control	NL Diagnosefunctie van de controle-LED's
<p>D Blinküberwachung und Leuchten-Substitution bei Ausfall der Anhänger-Blinkleuchten</p> <p>Der Ausfall von einer oder von beiden Anhänger-Blinkleuchten wird je nach Fahrzeugtyp und Ausführung des verbauten Elektro-Einbausatzes wie folgt angezeigt:</p> <ul style="list-style-type: none"> • Erhöhung / Verdoppelung der Blinkfrequenz • Volltextmeldung im Display / Kombi-Instrument • Aktivierung Kontrollleuchte für Lampenausfall • Akustische Warnung via Buzzer oder Voice-Message <p>Bei einem Blinkleuchten-Ausfall ersetzt die gleichseitige Rückleuchte durch Aufleuchten in der Blinkfrequenz eine defekte Anhänger-Blinkleuchte (Leuchten-Substitution!).</p>	<p>GB Indicator failure detection and lamp substitution if the trailer indicators fail</p> <p>The failure of a single or on both trailer indicators will be shown depending on the type of vehicle and electric kit installed as follows:</p> <ul style="list-style-type: none"> • Increase in the flashing frequency • Text message in the Display / combi-instrument • Activated control lamp for light failure • Audible warning via Buzzer or Voice-Message <p>If an indicator fails the left or right rear light compensates the faulty indicator by flashing at the correct frequency! (Lamp substitution).</p>	
<p>F Surveillance des clignotants et substitution des feux en cas de panne des clignotants de la remorque</p> <p>La panne d'un ou des deux clignotants de la remorque est indiquée de la façon suivante en fonction du type de véhicule et du modèle de module électrique monté:</p> <ul style="list-style-type: none"> • Augmentation / doublement de la fréquence de clignotement • Message complet sur l'affichage / l'instrument combiné • Activation du voyant de contrôle pour panne de lampe • Avertissement sonore via buzzer ou message vocal <p>En cas de panne du clignotant, le feu arrière du côté de la panne remplace un clignotant de remorque défectueux en s'allumant à la même fréquence que le clignotant! (Substitution des feux!).</p>	<p>I Controllo delle frecce e sostituzione delle lampade in caso di guasto alle frecce del rimorchio</p> <p>A seconda del tipo di veicolo e della versione del kit elettrico montato, il guasto di una o di entrambe le frecce del rimorchio si manifesta come segue:</p> <ul style="list-style-type: none"> • Aumento/raddoppio della frequenza di lampeggiamento • Full text display / strumento combinato • Attivazione della spia di controllo per il guasto lampada • Segnalazione acustica mediante cicalino o messaggio vocale <p>In caso di guasto alla luce della freccia, la luce posteriore dello stesso lato si accende sostituendo nella frequenza del lampeggio la freccia difettosa del rimorchio. (Sostituzione delle lampade!).</p>	
<p>E Control de intermitentes y sustitución de lámparas en caso de fallo de los intermitentes del remolque</p> <p>El fallo de uno o de ambos intermitentes del remolque se indicará de la siguiente manera en función del tipo del vehículo y de la ejecución del juego de montaje eléctrico montado:</p> <ul style="list-style-type: none"> • Aumento/duplicación de la frecuencia de parpadeo • Mensaje de texto completo en el display/instrumento combinado • Activación de la lámpara piloto para el fallo de lámparas • Advertencia acústica mediante zumbador o mensaje de voz <p>Si hay un fallo de intermitente, la luz trasera del mismo lado reemplazará la lámpara defectuosa del intermitente parpadeando en la misma frecuencia que el intermitente (Substitución de lámparas!).</p>	<p>NL Knippercontrole en lampvervangng bij uitval van de knipperlampen van een aanhangwagen</p> <p>De uitval van één of beide knipperlampen van een aanhangwagen wordt afhankelijk van het voertuigtype en de uitvoering van de ingebouwde elektroset als volgt aangegeven:</p> <ul style="list-style-type: none"> • Verhoging / verdubbeling van de knipperfrequentie • Volledige tekstweergave op het display / combi-instrument • Activering controlelampje voor uitval van een lamp • Akoestische waarschuwing via buzzer of Voice-Message <p>Bij een uitval van (een) knipperlamp(en) vervangt het gelijkzijdige achterlicht door aan te flitsen bij de knipperfrequentie een defecte knipperlamp van een aanhangwagen (Lampvervangng!).</p>	

ERKLÄRUNG SYMBOLE	SYMBOL EXPLANATION	EXPLICATION DES SYMBOLES	SPIEGAZIONE DEI SIMBOLI	EXPLICACIÓN DE LOS SIMBOLES	VERKLARING SYMBOLEN
(D)	(GB)	(F)	(I)	(E)	(NL)
	linke (58-L) bzw. rechte (58-R) Schlussleuchte	feu arrière gauche (58-L) respectivement droite (58-R)	luce posteriore sinistra (58-L) rispettivamente destra (58-R)	pilato trasero izquierdo (58-L) respectivamente derecho (58-R)	Linker (58-L) c.q. rechter (58-R) achterlicht
	Bremsleuchte (54) / 3. Bremsleuchte (54)	feu de stop (54) / 3ième feu de stop (54)	luce d'arresto (54) / 3. luce d'arresto (54)	luz de freno (54) / tercera luz de freno (54)	Remlicht (54) / 3e remlicht (54)
	Fahrtrichtungsanzeiger links	feu indicateur de direction gauche	indicatore di direzione sinistra	luz indicadora de dirección de marcha izquierda	Richtingaanwijzer links
	Fahrtrichtungsanzeiger rechts	feu indicateur de direction droite	indicatore di direzione destra	luz indicadora de dirección de marcha derecha	Richtingaanwijzer rechts
	Nebelschlussleuchte(n)	feu (x) arrière (s) de brouillard	fendinebbia	luz (-ces) trasera (s) antinebla (s)	Mistachterlicht(en)
	Rückfahrleuchte(n)	feu (x) de marche arrière	luce (i) retromarcia	luz (-ces) de marcha atrás	Achteruitrijlicht(en)
	Dauerstrom / Steckdose 13P Kammer 9	courant continue / prise de courant à 13 pôles, compartiment 9	alimentazione continua / presa 13 poli, camera 9	positivo continuo / caja de anclaje a 13 polos, cámara 9	Continustroom / stekkerdoos 13P kamer 9
	Ladeleitung / Steckdose 13P Kammer 10	cable de charge / prise de courant à 13 pôles, compartiment 10	cavo di carica / presa 13 poli, camera 10	cable de carga / caja de anclaje a 13 polos, cámara 10	Laaddraad / stekkerdoos 13P kamer 10
	Anhängerkennung	remorque / détection de la fonction "remorque"	rimorchio / riconoscimento rimorchio	remolque / detección del remolque	Aanhanger / aanhangertentificatie
	Dauerstrom / permanente Stromversorgung	courant continue / alimentation électrique permanente	corrente / alimentazione continua	positivo continuo / alimentación de corriente permanente	Continustroom / permanente stroomvoorziening
	Masse (31)	masse (31)	massa (31)	masa (31)	Massa (31)
	Batteriepolschlüsse Anschluss Minus	borne "moins" de la batterie	connessione negativa della batteria	conexión negativa de batería	Accuopoolklem aansluiting min
	Batteriepolschlüsse Anschluss Plus	borne "plus" de la batterie	connessione positiva della batteria	conexión positiva de batería	Accuopoolklem aansluiting plus
	Sicherungsstärke 20 Ampère	ampérage 20 ampères	fusibile / fusibile con capacity 20 Ampère	fusible / amperaje 20 amperes	Zekering / zekeringsterkte 20 Ampère
	Zigarettenanzünder / Zubehör-Steckdose	allume-cigare / prise d'accessoires	accendisigari / presa accessori	encendedor de cigarrillos / caja de accesorios	Sigarettenaansteker / accessoires stekkerdoos
	Lautsprecher / Warnsummer	haut-parleur / vibreur	autoparlante / cicalino	altavoz / señal acústica de advertencia	Luidspreker / waarschuwingszoemer
	Einparkhilfe	assistance au parking	sensori di parcheggio	ayuda para aparcar	Inparkeerhulp
	Schalter / Funktionsursprung	interrupteur / origine de fonction	interruttore / origine funzione	interruptor / origen de función	Schakelaar / functieoorsprong
	verbinden	raccorder	connessione	conectar	Koppelen
	trennen	séparer	sconnessione	separar	Ontkoppelen
	beachten / siehe weitere Informationen	considérer / voir informations ultérieures	considerare / vedere ulteriori informazioni	considerar / véase las informaciones	Let op / bekijk verdere informatie
	beachte auserwähnten Bereich	faire attention à la zone sélectionnée	considerare area selezionata	considerar el área seleccionada	Let op gekozen bereik
	vorhanden / belegt / i.O.	disponible / occupé / OK	presente / occupato / OK	presente / ocupado / OK	Aanwezig / bezet / i.o.
	nicht vorhanden / nicht belegt / nicht i.O.	pas disponible / pas occupé / pas OK	non presente / non occupato / non OK	non presente / non ocupado / non OK	Niet aanwezig / niet bezet / niet i.o.
	links	gauche	sinistra	izquierdo	Links
	rechts	droite	destra	derecho	Rechts
	Akustische Signalisierung	signalisation acoustique	segnalazione acustica	señalización acústica	Akroestische signalering
	Achtung / wichtiger Hinweis	attention / important advice	attenzione / indicazione importante	atención / indicación importante	Attentie / belangrijke instructie